



Scientific / Metrology Instruments
Scanning Electron Microscope

Solutions for Innovation

JSM-IT500 Series



JEOL Ltd.

In
TouchScope™

JSM-IT500 series



To the next generation

Fast and Easy Analysis!

Features of **JSM-IT500**

- Zeromag for fast navigation
- Live Analysis* real time EDS analysis during observation.
- SMILE VIEW™ Lab for integrated management of image & analysis data
- Guided operation! Specimen Exchange Navi

* Standard in the A/LA version.



Fast and Easy Analysis!

Equipped with Live Analysis software*¹, the JSM-IT500 facilitates any analyses from specimen loading to report generation.



You can view a video via this QR code.



Main Screen
Displays Holder Graphics or CCD Image*²

Locate the specimen area or specify analysis positions with Holder Graphics or CCD image.*²

You can rapidly search the specimen area. It is also easy to specify positions for multiple-field serial analysis.



Holder Graphics

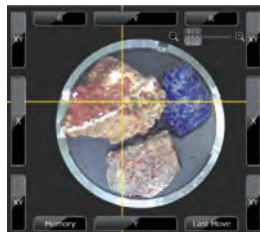

CCD image*¹ acquired with Stage Navigation System



Element

Display of elemental composition and "Alert" on live image

Live Analysis

Only for A/LA

A real time EDS analysis*¹ during observation

With our Analytical series, the embedded EDS system shows a real time EDS spectrum during image observation.

Display of elemental composition and "Alert" on live image.

Conventional SEM — Example using multiple software systems —

There were many steps up to report generation using the conventional SEM.

Search the specimen area

If there are multiple specimens, take photos or notes.

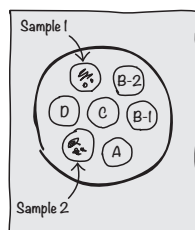

SEM observation

Find the target area at low magnification and acquire a high-magnification image.

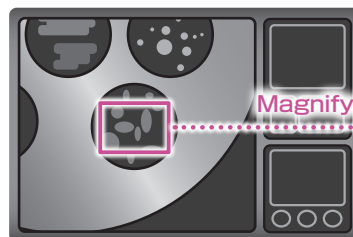

Search the specimen area while viewing notes.

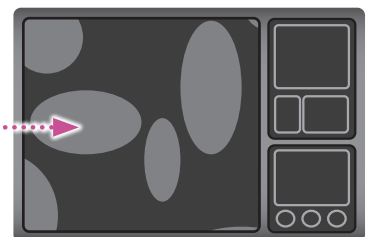

Take a photo at high magnification.

Repeat the same step for the number of areas needed.



Integrated data management software

List of captured images

Integrated report generation

Select and review images and analysis results through the data management area. Generate a report with a single click.



Spectrum

Data management button

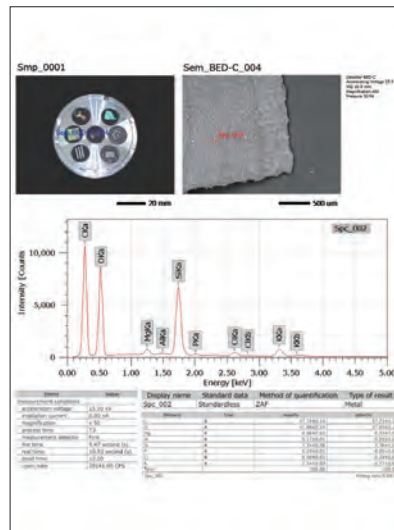

Report example

*1 This function is standard in the A/LA versions.

*2 To take a CCD image, SNS (option: p17) is required.

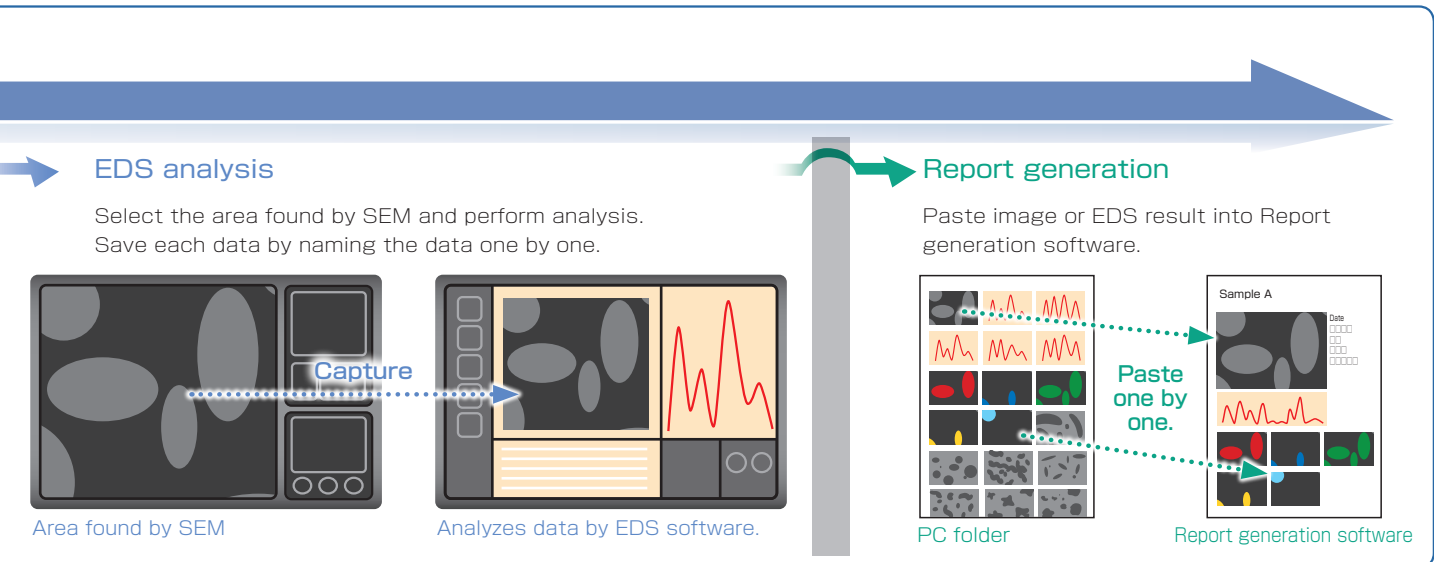

True Integration of Optical and SEM imaging

Zeromag

New functions to easily search the specimen area

Smooth operation up to high magnification observation

Zeromag is a function which links the SEM image with the Holder Graphic or CCD Image*¹ where all are linked to the stage coordinates. This facilitates navigation with seamless transitioning from the optical to SEM image.

- Features of Zeromag**
- Seamless transition from optical to SEM image.
 - Can pre-select multiple analysis points across your specimen set.
 - Displays areas analyzed for easy review or fast return for additional study.

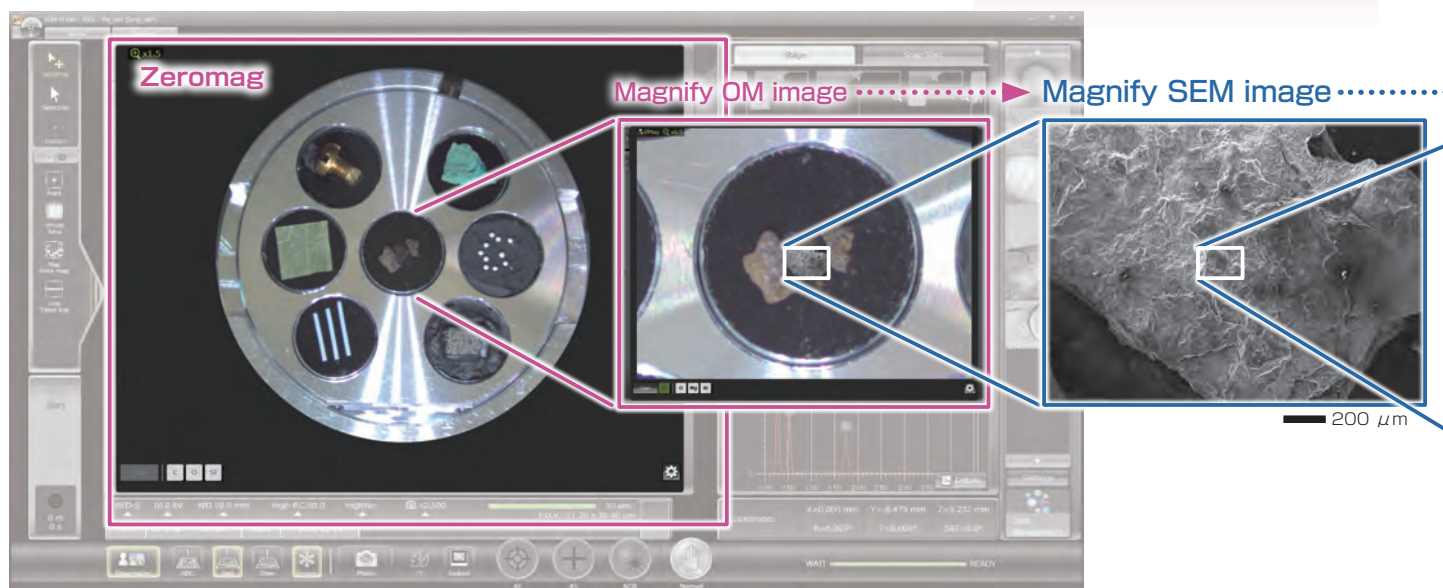

Zeromag image displayed on the main screen.

Montage

Automated simple large-area observation and analysis*² can be made using Zeromag.

Montage is an effective function to acquire detailed information and for identifying foreign materials over large areas. With Zeromag, it is easy to set up one or more montage areas for imaging and analysis. "tilt correction", "field overlap" and "Autofocus point setting" functions are built in.

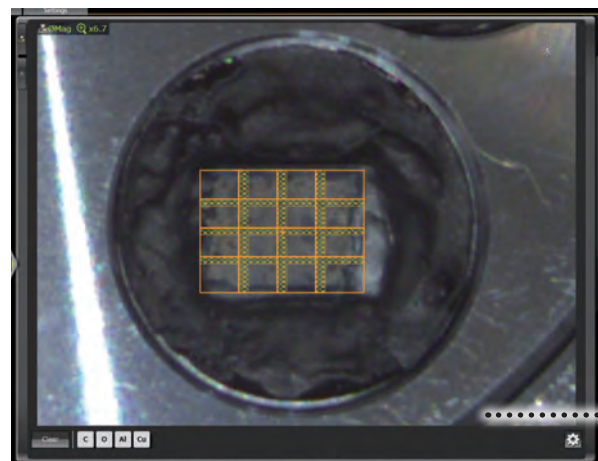

Montage setup with Zeromag.

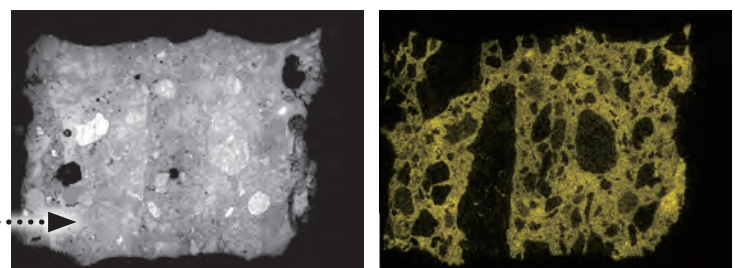

Montage result. 4 × 4
 (Left : Backscattered electron composition image, Right : Ca map)
 Specimen : Concrete. Accelerating voltage : 15 kV
 High-vacuum mode. Area : Approx. 4 mm × 3 mm

The JSM-IT500 is a revolutionary SEM that enables observation to high magnification with fewer steps.

● Secondary electron image

This example shows a high magnification image of iron rust which highlights fine surface morphology of the rust particles.

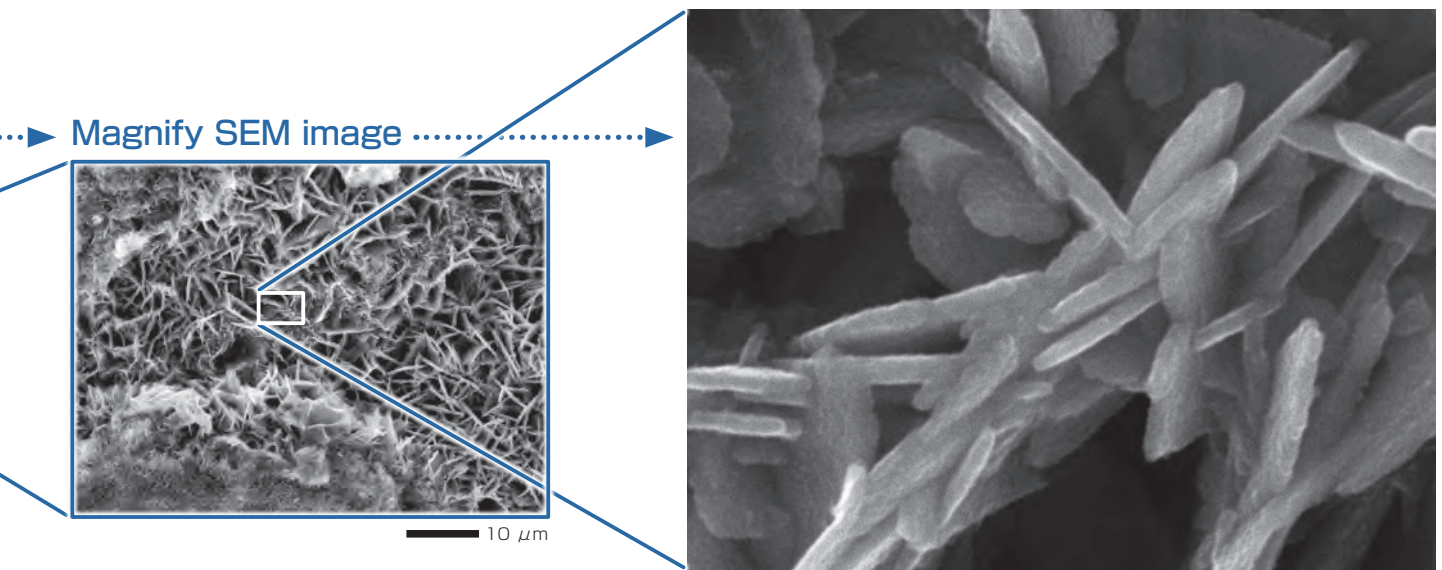

Specimen : Iron rust. Accelerating voltage : 25 kV Magnification : × 50,000 High-vacuum mode. Secondary electron image.

● Backscattered electron image

Option for BU/A
Standard for LV/LA

Backscattered electron composition image of a cemented carbide cross section. Differences in crystal orientations (channeling contrast) of each tungsten carbide particle can be observed from a backscattered electron composition image at low accelerating voltage.

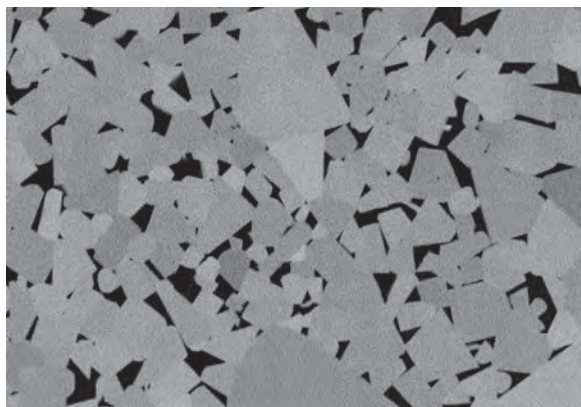

Specimen : Cemented carbide. Uncoated. Accelerating voltage : 5 kV Magnification : × 10,000 High-vacuum mode. Backscattered electron composition image.

● Scan system for better image quality at low accelerating voltage

You can select a scan system, which adopts fast frame-accumulation to reduce specimen charging. Thus, higher-magnification observation of charge-susceptible specimens or beam-sensitive specimens is facilitated even at low accelerating voltage.

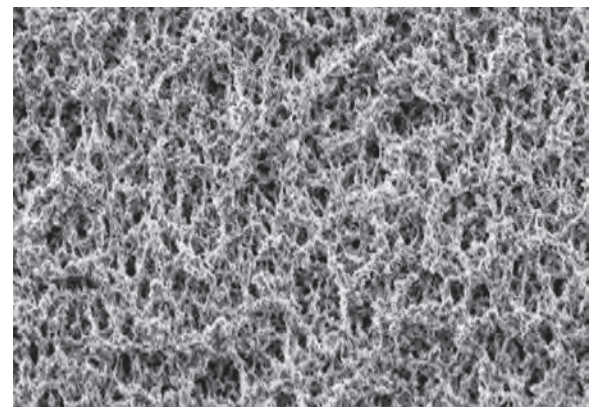

Specimen : Hollow fiber. Uncoated. Accelerating voltage : 1.5 kV Magnification : × 10,000 High-vacuum mode. Secondary electron image.

*1 : To take a CCD image, SNS (option) is required.
*2 : This function is standard in the A/LA versions.

Low vacuum mode

Only for LV/LA

Differential pumping, performed near the objective lens, has greatly improved the image quality in low vacuum mode. With a pressure range up to 650 Pa, a wide variety of sample types can be studied in their native state.

Ultra low vacuum image

Specimens containing a large amount of water can be especially sensitive to vacuum conditions in the SEM chamber. These types of specimens are traditionally challenging to observe in conventional SEM modes without special treatment. With the extended pressure range (up to 650 Pa) of our JSM-IT500LV/LA series, these types of specimens are easily observed.

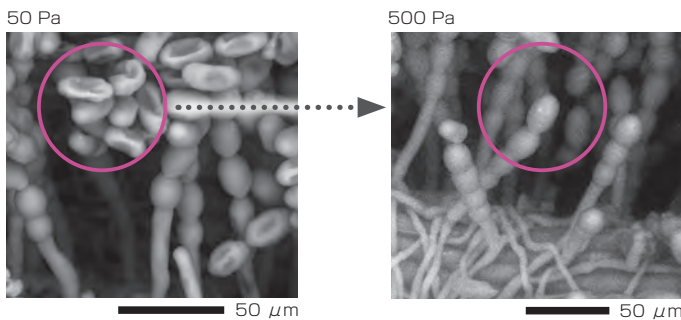

Specimen : Mildew fungi.
Accelerating voltage : 15 kV Magnification : × 200
Low-vacuum mode : 50 Pa, 500 Pa Backscattered electron composition image.

Low-vacuum secondary electron image

Option for LV/LA

A low-vacuum secondary electron image provides shaper details of the specimen surface even in low vacuum mode.

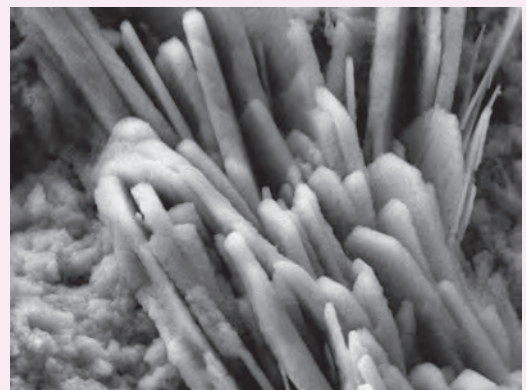

Specimen : Cement hydrate.
Accelerating voltage : 10 kV Magnification : × 10,000
Low-vacuum mode : 30 Pa
Low-vacuum secondary electron image.

Observation of water droplet

Cool stage* & Vacuum pressure of 650 Pa

When you observe a cooled specimen (0 °C with the cool stage) at a pressure of 650 Pa, water droplets can be observed.

The figure at the right shows an example of a water droplet on a water-repellent textile using the Aqua Cover method*.



Specimen : Water droplet on a water-repellent textile.
Accelerating voltage : 30 kV Magnification : × 80
Low-vacuum mode : 650 Pa Backscattered electron composition image.

200 μm

* Cool stage and Aqua Cover method are options.

Measurement functions

Several measurement functions are built in.

Measurement

Measurements are performed on the observation screen, and their results (distance, angle, area, etc.) can be recorded and saved on SEM images.

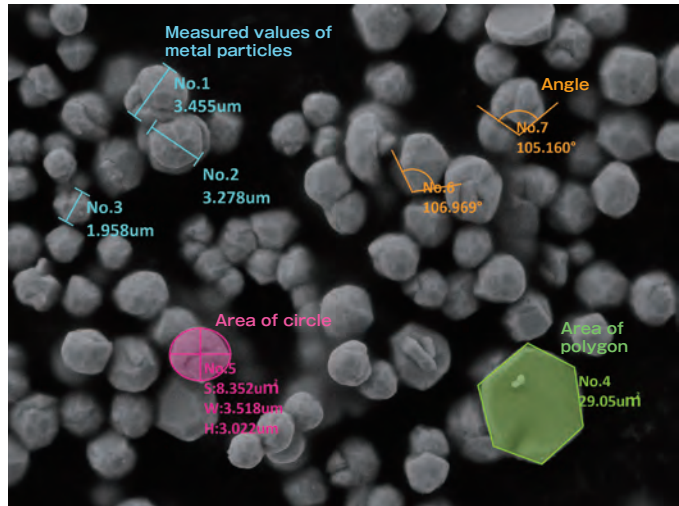

Specimen : Metal particles.

3D imaging

Creation of 3D image and analysis options.

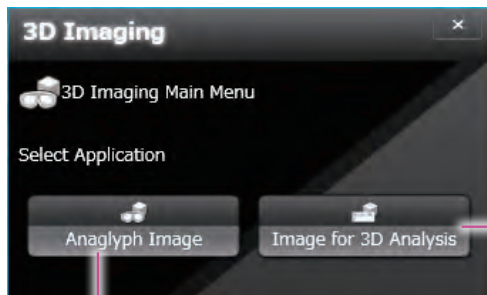

● Anaglyph

Step by step guide to collecting images for creation of an anaglyph image.

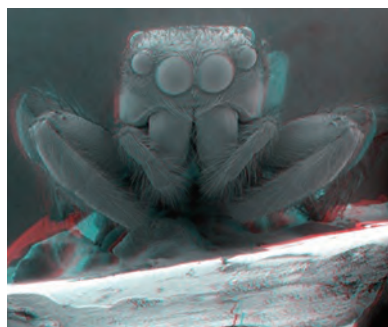

Specimen : Jumping spider (salticid)

● 3D measurement image

Option

Dedicated software for 3D measurement. A 3D image can be created from two SEM images. The topographic status of the specimen surface can be measured using the 3D image.

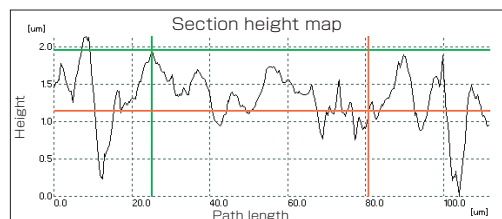
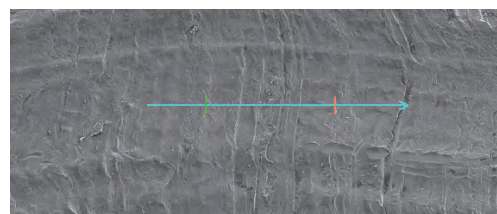
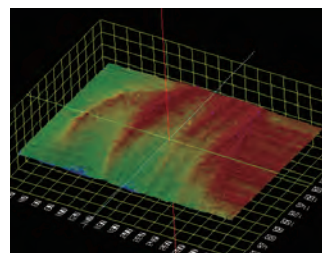

Seamless SEM and EDS

Live Analysis

Only for A/LA

Real time display of elemental analysis results during observation

With our Analytical series, the embedded EDS system shows a real time EDS spectrum during image observation. You will easily find elements of interest and unexpected elements.

Features of Live Analysis

- Always displays the characteristic X-ray spectrum.
- Display of the main constituent elements.
- Alert display of elements of interest.

Electron microscope operation screen

You can confirm spectra and the main constituent elements during observation.

Each analysis area, linked to the corresponding stage coordinates, is displayed on Holder Graphic image or CCD image.*1



Element

The main elements existing in the measurement area are displayed. You can display an "Alert" by specifying an element.

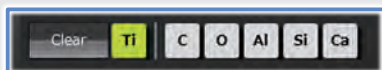

Spectrum

The characteristic X-ray spectrum from the measurement area and automatic qualitative analysis results are always displayed.

Single-click enables you to switch between the Electron microscope operation screen and analysis detail display screen.

EDS

The Energy Dispersive X-ray Spectrometer (EDS), an optional attachment to the Scanning Electron Microscope (SEM), performs elemental analysis by detecting characteristic-rays generated from a specimen due to electron beam irradiation.

Analysis detail display screen

Qualitative and quantitative analysis, collect spectral maps and line scans...through the Analysis Detail display screen. Even during an analysis, you can generate reports from acquired data (through the Data management screen, p17).

Elemental map analysis screen



Switch between a composite map view or periodic table.

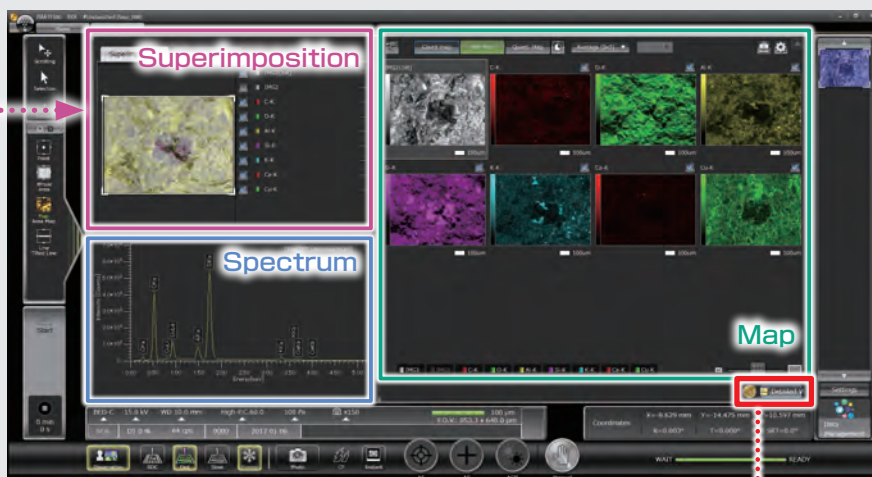

You can also switch from "Map" screen to the Electron microscope operation screen.

Spectral analysis screen

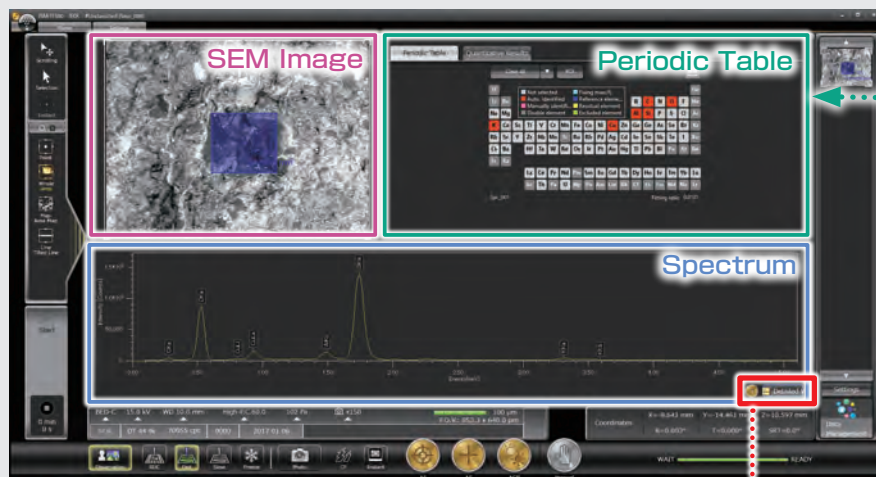

You can also switch between "Periodic Table" and "Quantitative Results".

● Relocating analysis areas

The stage position and magnification are linked with the analysis data. Return to any analysis area for additional study.

● Pinpoint Navi

Automatic serial analysis can be made by specifying multiple areas in advance. Pinpoint Navi detects small image shifts by probe tracking, for precise repositioning of the analysis area.

* To take a CCD image, SNS (option) is required.

Qualitative & quantitative analysis

You can directly specify the analysis positions or analysis points in the SEM field by clicking on the Electron microscope observation screen.

Specifying multiple analysis positions or multiple analysis points on multiple SEM fields with Zeromag, facilitates automatic serial analysis.

Identification of elements

● Qualitative analysis

Automatic qualitative analysis is performed during observation. Double-clicking on small peaks identifies the corresponding elements. Identification of elements can be made during the spectral acquisition.

● Area-specifying types

To specify the analysis region, various types are available. They include "Point", "Area", and also "Particle" that allows you to specify the analysis area from the intensity difference in an image.



Particle
Specifies areas with the same image intensity.



Polygon
Specifies the inside of an indefinite shape enclosed by a circle.



Point
Performs spectral analysis of a specified point.



Whole Area
Acquires a spectrum from the whole observation area and/or a specified area.



Ellipse
Specifies an area inside a circle.



Free Line
Specifies an elongated region (grain boundary, etc.).

● Analysis example

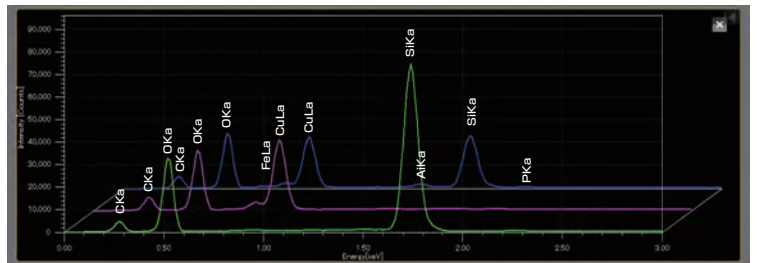
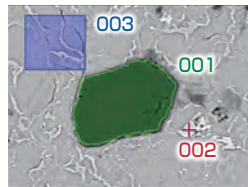
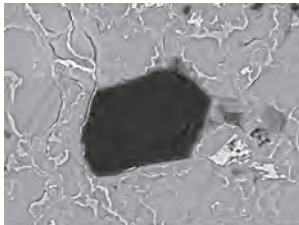

003
002
001

Specimen : Chrysocolla. Accelerating voltage : 15 kV
Magnification : × 700 High-vacuum mode : C coating. Backscattered electron composition image.

Examination of the element volume

● Standard-less quantitative analysis

When you click the quantitative analysis result tab on the analysis detail display screen, the quantitative analysis results will be displayed. ZAF correction is built in and PRZ method is available. The quantitative analysis result is displayed as the mass concentration and the ratio of the number of each element.

● Standard quantitative analysis

The ability to perform quantitative analysis with standards is also built in.

Displayname	C	O	Al	Si	Ca	Fe	Cu	Total
Spc_002	20.83	43.60	0.17	33.70	0.01	0.09	1.60	100.00
Spc_003	15.19	33.17	0.14	0.18	0.00	0.48	50.85	100.01
Spc_001	18.69	32.52	0.90	13.92	0.29	2.98	30.70	100.00
Average	18.24	36.43	0.40	15.93	0.10	1.18	27.72	
StandardDeviation	2.32	5.08	0.35	13.76	0.13	1.28	20.22	

Accuracy improvement for qualitative analysis

● Visual Peak ID (VID)

This function enables you to confirm whether the constituent elements are correctly identified in the qualitative analysis result. A spectrum is reconstructed based on the X-ray intensity of the elements identified.

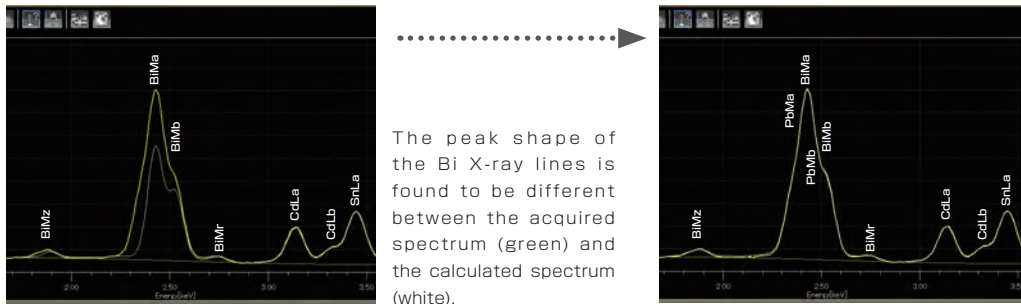

The peak shape of the Bi X-ray lines is found to be different between the acquired spectrum (green) and the calculated spectrum (white).

Re-examination at the Bi peak position indicated the presence of Pb. When Pb was added to the analysis results, the two peak shapes matched. From this result, Pb was confirmed to be contained in the specimen.

Drift compensation built in

● Probe tracking

With long data acquisitions, the system periodically compares the electron microscope image at analysis start with the current image, so as to maintain the same analysis area. This capability helps you to monitor any change in a specimen or specimen drift during long acquisitions.

Line analysis

Finding the concentration change of elements along a line

Line analysis performs elemental analysis along a line set on an electron microscope image. The X-ray intensity of the specified elements is plotted to show the change in concentration across the line. You can change elements to show during or after completion of spectral acquisition.

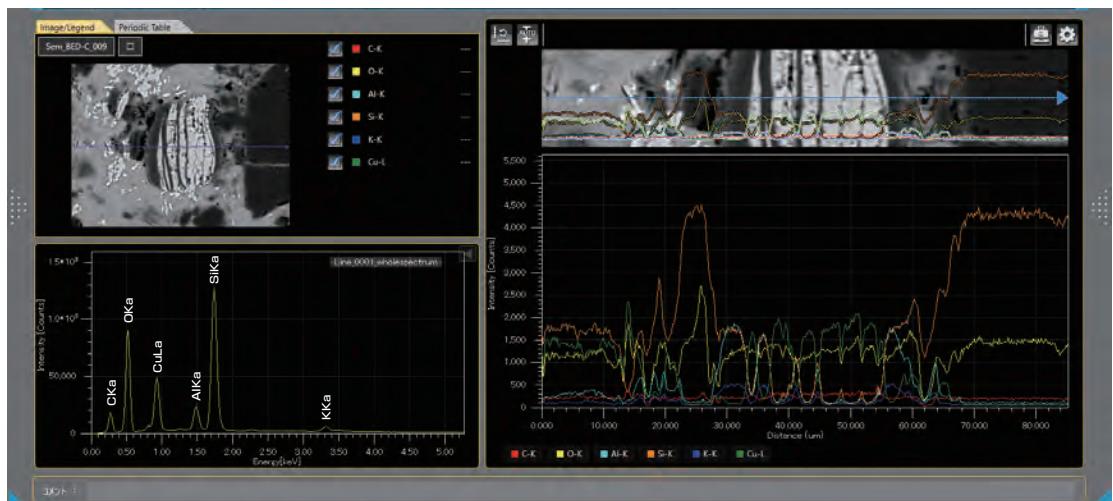

Elemental map

The elemental map allows you to acquire the elemental distribution from the whole observation screen or in an area specified in the observation screen. Since the spectral information is saved at each pixel, you can acquire map data sets without specifying elements as well as add or modify elements during and after data acquisition. Display of the net map can be made in real time.



Displaying the elemental distribution with selected area

● Count map

The count map displays the X-ray intensity distribution from the specified energy region. The whole map enables you to acquire the distribution from all the area. The area map allows for acquisition of an SEM image and elemental maps in a specified area.

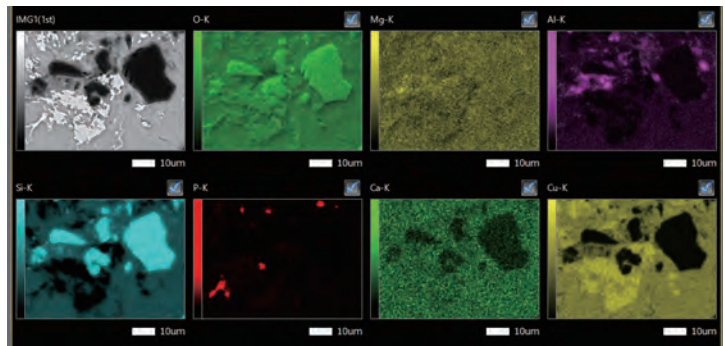

Backscattered electron composition image and elemental maps
Specimen : Chrysocolla

Improved accuracy of elemental map

● Net map

The Net map separates spectral peaks at each pixel and shows an elemental map with a reduced effect of close peaks. Compared to the count map which unavoidably reflects the peak intensity of other elements close to a specified element, the Net map enables a real-time display of an inherent-intensity elemental map even from a specimen containing various elements.

● Quantitative map

The quantitative map, which adds correction calculations to the Net map, shows a map with quantitative values.

In addition to the Net map that shows the inherent-intensity elemental map, the quantitative values can be displayed with image contrast.

● Comparison of Intensity map and Quantitative map

Spectral peaks of Cd-L β (3.313 keV), Cd-L β 2 (3.528 keV) and Sn-L α are close to each other. Thus in the intensity map, it is difficult to separate Cd from Sn.

Applying the quantitative map enables you to confirm the inherent Sn distribution.

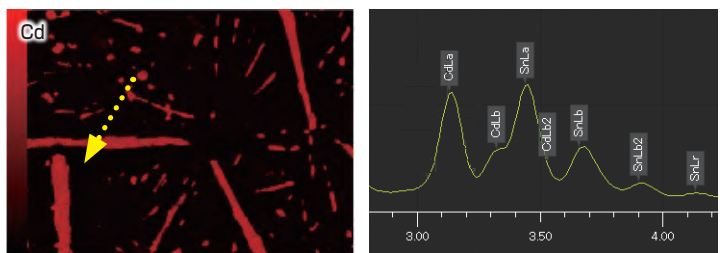

Cd intensity map

20 µm

Peaks of Cd and Sn

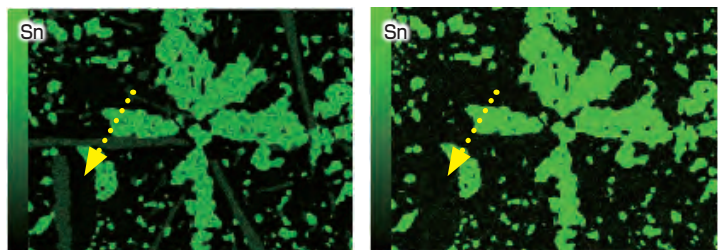

Sn intensity map

20 µm

Sn quantitative map

20 µm

Specimen : Wood metal

Real time analysis using elemental map

● Pop-up spectrum

Since the stored map has spectral information, you can extract spectra from anywhere within the map data set. If there is an area that was not displayed in the specified elemental map, spectral display of that area is performed, thus allowing for confirmation of whether or not you missed elements.

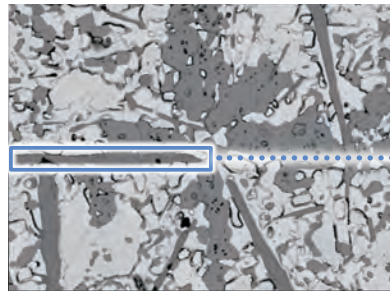

Backscattered electron composition image
Specimen : Wood metal.

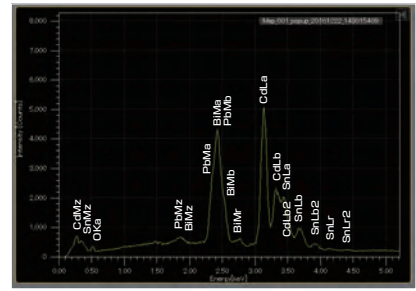

Pop-up spectrum enclosed by a Blue square

Locating the positions of an elemental map on an SEM image

● Color-overlay display of an elemental map

The system allows you to overlay elemental maps on the SEM image in real time. In the area where multiple elements overlap, the area is displayed with a composite color.

Red Cd-L
Green Sn-L
Blue Pb-M
Yellow Bi-L

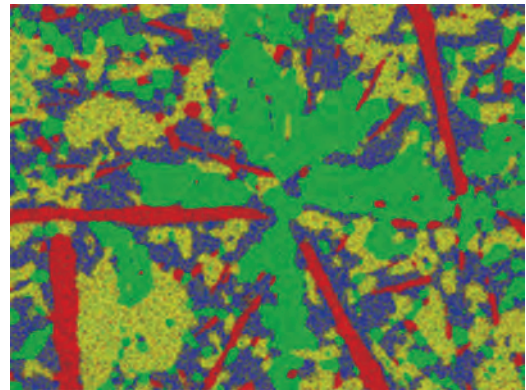

Multi-color overlay display
Specimen : Wood metal

Confirming the elemental distribution in a short time

● Real-time filter

The system allows for image processing during a map acquisition to improve the signal to noise ratio. This feature provides fast confirmation of the element distribution.

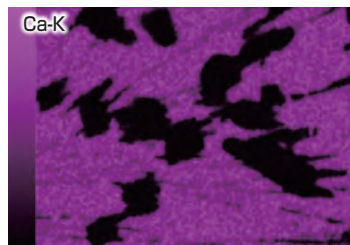

10 μm

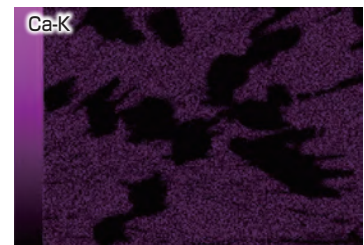

10 μm

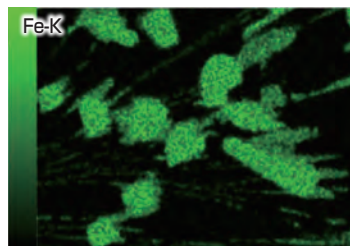

10 μm

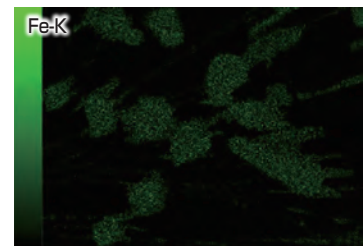

10 μm

Specimen : Black ore
Dwell time : 0.1 ms
Number of frames : 4 frames
Pixels : 512 × 384 pixels

Real-time filter ON
Average (5 × 5)

Real-time filter OFF

Particle analysis

Automatic analysis for particles and foreign materials

● Particle analysis

Particle analysis can be performed based on the intensity difference in a backscattered electron composition image as well as by size and shape. This feature extends to applications such as inclusions in addition to particles collected on filters.

● Statistical processing

For each particle, EDS analysis results and particle-shape information (particle diameter, area, etc.) are recorded. You can create graphs or tables from the information for statistical processing.

● Example of automatic analysis (asbestos)

The system extracts the target particles from the specimen and performs automatic EDS analysis of each particle to determine whether or not the analyzed particle is asbestos. In addition, the system identifies the type of asbestos from composition, and classifies the particles into the type of asbestos and performs statistical processing.

After the analysis completes, you can re-confirm each particle and analysis results.

Particle analysis conditions	0001
Total	33
Crocidolite	9
Amosite	1
Chrysotile	4
Unknown	19

Classified asbestos

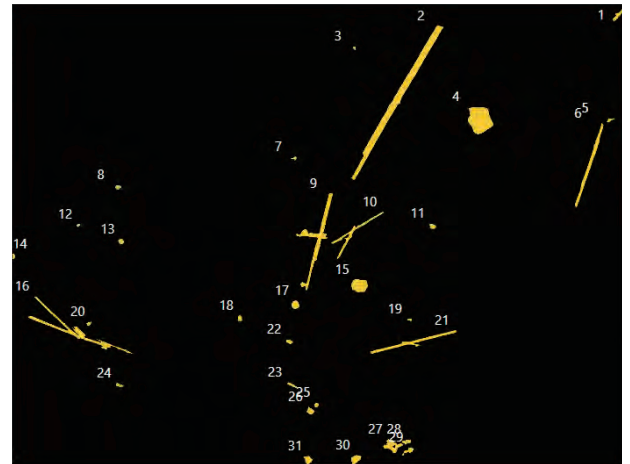

Particle analysis result

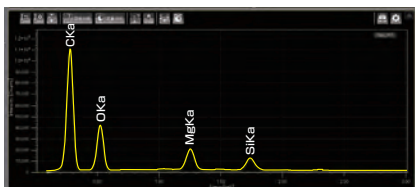
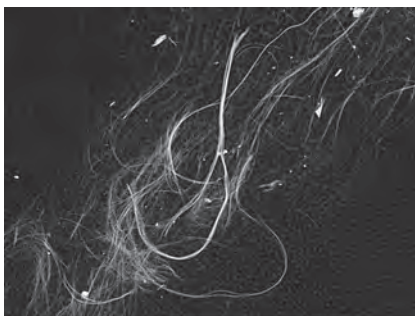

Chrysotile

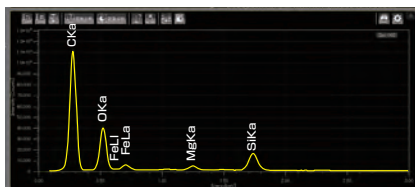
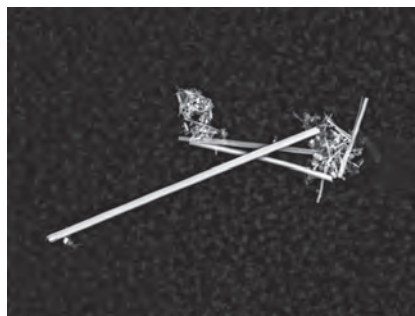

Amosite

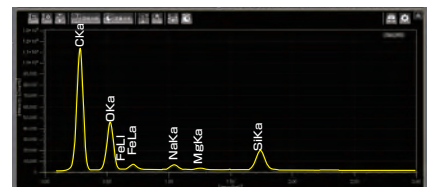
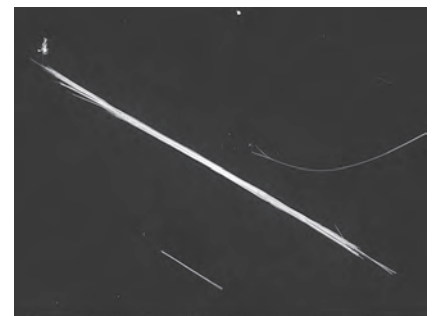

Crocidolite

DrySD™ Detector

The DrySD™ Detector (Dry Silicon Drift Detector: SDD) does not require liquid nitrogen, unlike the conventional Si(Li) type EDS detector. Thus, maintenance is easier along with faster speed to analysis.

In addition, DrySD™ Detector performs high X-ray count analysis without degrading high energy resolution. A large detection area DrySD™ Detector provides elemental analysis at small probe currents. The JSM-IT500 can support multiple DrySD™ Detectors for even higher throughput or minimization of shadowing with topographic specimens.

- Features of DrySD™ Detector**
- Fast analysis. Power on and ready for operation in a few minutes.
 - No liquid nitrogen is required.
 - Capable of analysis at large probe currents and high count rates while maintaining high energy resolution.
 - Improved resolution for low energy regions.



Specifications for DrySD™ Detector

Detection area	Energy resolution	Detectable elements
10 mm ² , 30 mm ²	129.0 eV or less	Be to U
60 mm ² , 100 mm ²	133.0 eV or less	B to U



Seamless data generation

Integrated data management software SMILE VIEW™ Lab

SMILE VIEW™ Lab is a fully integrated data management software which links the CCD image*¹, SEM images, EDS analysis results*² and corresponding stage coordinates for fast report generation or re-call of sample position for further study.

SMILE VIEW™ Lab Data management screen

SMILE VIEW™ Lab Data management screen allows you to execute integrated management of all the data. This data manager saves the data, which links the observation position, observation & analysis results, and a low magnification image acquired by Holder Graphic or CCD image*¹. You can review or re-analyze already-acquired data and export them to a report.

Features of SMILE VIEW™ Lab

- Performs integrated data management of CCD image*¹ data, SEM image data and EDS analysis result*².
- Allows for immediate understanding of the data for each field.
- Enables various data search.

Names of each field are displayed.

Data search is enabled from specimen name, creation time, data type, etc.

Positions of each field are displayed on Holder Graphic or CCD image*¹.

Mark	Name	User name	Creation datetime	Modified datetime	Folder name	Data type	Comm	C	O	Mg	Al	Si	P	Cl	K	Cu	Sum	
	Grp_001				Pj_001*Smp_0...													
	Map_001	JEOL	2016/12/21 17:44	2016/12/21 17:53	Pj_001*Smp_0...	Map												
	Sem_BED-C_001	JEOL	2016/12/19 11:41	2016/12/19 11:41	Pj_001*Smp_0...	Fov Image												
	Sem_BED-C_002	JEOL	2016/12/19 11:44	2016/12/19 11:44	Pj_001*Smp_0...	Fov Image												
	Sem_BED-C_003	JEOL	2016/12/19 11:46	2016/12/19 11:46	Pj_001*Smp_0...	Fov Image												
	Sem_BED-C_004	JEOL	2016/12/19 11:52	2016/12/19 11:52	Pj_001*Smp_0...	Fov Image												
	Sem_BED-C_017	JEOL	2016/12/21 17:34	2016/12/21 17:34	Pj_001*Smp_0...	Fov Image												
	Sem_SED_001	JEOL	2016/12/21 16:47	2016/12/21 16:47	Pj_001*Smp_0...	Fov Image												
	Smp_0001	JEOL	2016/12/19 11:35	2016/12/21 18:09	Pj_001*Smp_0...	Sample I...												
	Spc_001	JEOL	2016/12/21 17:39	2016/12/22 17:48	Pj_001*Smp_0...	Spectrum		8.44	47.23	2.67	30.11			1.35	10.20	100.00		
	Spc_001	JEOL	2016/12/19 11:47	2016/12/19 11:48	Pj_001*Smp_0...	Spectrum		47.74	41.88	0.56	0.17	7.34	0.19	0.58	1.54	100.00		
	Spc_002	JEOL	2016/12/19 11:52	2016/12/22 17:34	Pj_001*Smp_0...	Spectrum												

Data is displayed in list form, which includes analysis data, quantitative analysis result of elemental map, spectra, etc., in the selected fields.

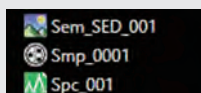

*1 To take a CCD image, SNS (option) is required.

*2 This function is standard in the A/LA versions.

User layout

You can create templates for your reports.

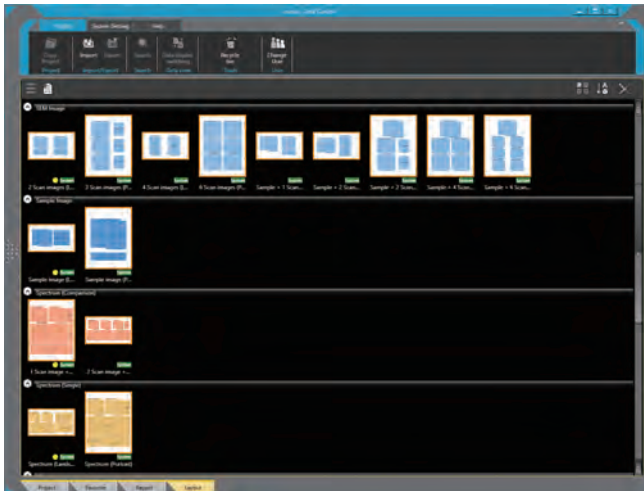

User layout

Automatic layout function

This function performs automatic layout depending on the data type (images, spectra, etc.). If the data set is large, additional pages are allocated automatically.

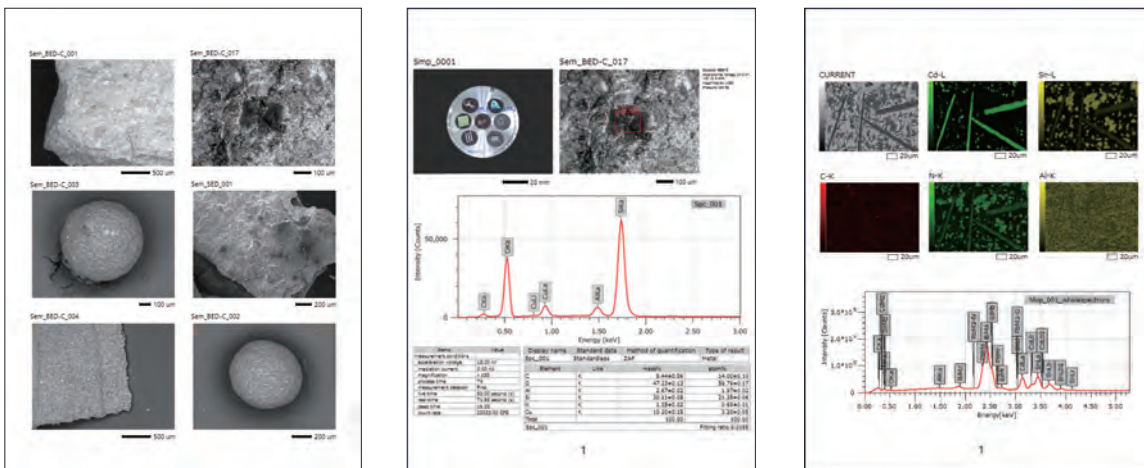

Automatic layout

Offline analysis software

Option

Improving productivity

Offline analysis software is available. You can process all your data offline and generate reports. You can create quantitative maps and extract spectrum (Pop-up Spectrum) from elemental mapping.

Specimen Exchange Navi & Large analytical

Safe and easy! Specimen Exchange Navi

Guided operation from sample introduction to observation



Safe specimen exchange

When venting chamber, the stage is automatically set to the exchange position for fast and easy specimen exchange. Can input a height offset for tall samples.

Recipes built in to automatically set observation conditions

During vacuum evacuation, the navigation flow allows you to acquire CCD image*, specify the observation field and set observation conditions using Recipes.

* To take a CCD image, SNS (option) is required.

Specimen Navigation

Functions to support specimen navigation

Holder Graphics

Holder Graphics allows you to immediately confirm the specimen position by showing the current specimen position including the specimen tilt and rotation.

Stage Navigation System (SNS)

The specimen position can be set by acquiring a color image of the specimen and double-clicking the image. Displaying the color image on the Zeromag screen allows for an easy search of the specimen area.

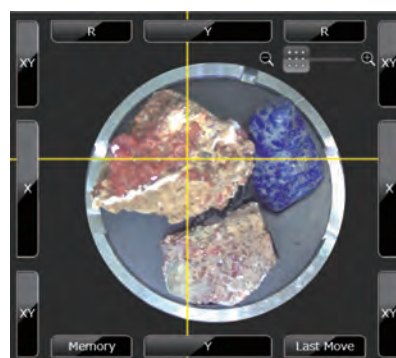

Option

CCD image area :
10 × 10 cm
Number of pixels :
5,000,000 pixels
Digital zoom : To × 20

specimen chamber



- “Image at designated magnification” of the target area is displayed immediately after the completion of chamber evacuation.

a state where :

- Target observation area was specified.
- Observation conditions were set.
- Image adjustment was executed.

Specimen exchange

Maximum specimen size : 200 mm dia.
Maximum specimen height : 90 mm (H)

Draw-out method

The stage is mounted in the chamber which allows a user to secure large or odd shaped specimens on the stage and position the area of interest under the objective lens prior to closing the door and evacuating the chamber.

Load lock chamber (LLC)

Load lock chamber (LLC, pre-evacuation chamber) is available for even faster specimen exchange.

Option

Safety mechanisms built in

Entering specimen height

User can input specimen height offset to further enhance stage safety limits.

Chamber scope (CS)

Camera which displays the relationship of the specimen to the detectors and objective lens pole piece.

Option

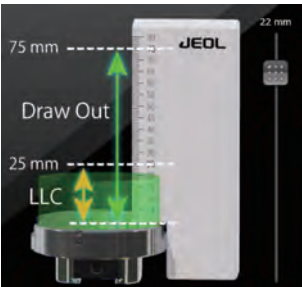

Switch between Holder Graphics view, Stage Navigation System or Chamber Scope view with a quick swipe on the display.

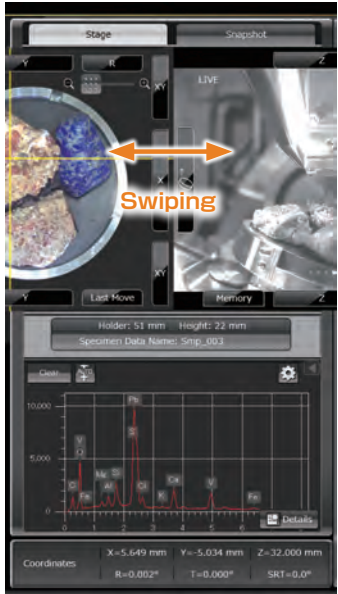

Multi-purpose chamber

Several attachments can be placed

On this multi-purpose chamber with 11 ports, the location of each detector is optimized. EDS, EBSD and WDS can be performed at the same working distance (10 mm).

The two EDS ports and the EBSD port are coaxially arranged, perpendicular to stage tilt, thus EDS/EBSD can be performed simultaneously and the complete opposing type Dual EDS is available.

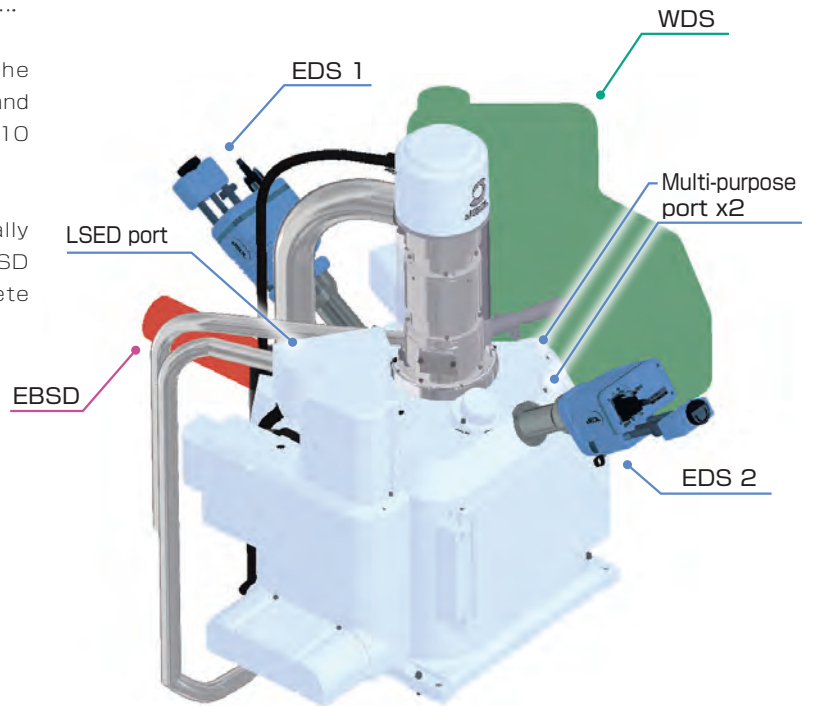

Example of Multi-purpose chamber with two EDSs, WDS and EBSD

High-speed, high-precision motor stage and high-speed vacuum system

High-speed, high-precision motor stage

The JSM-IT500 comes with a 5-axis motor stage that accommodates a maximum load of 2 kg.

- High-speed, High-precision
- Maximum load : 2 kg

High-speed evacuation

The specimen chamber evacuation takes approximately 2 minutes and 50 seconds*. The newly designed vacuum system with the turbo molecular pump and the foreline trap achieves a clean vacuum.

- Evacuation : Approximately 2 minutes and 50 seconds*

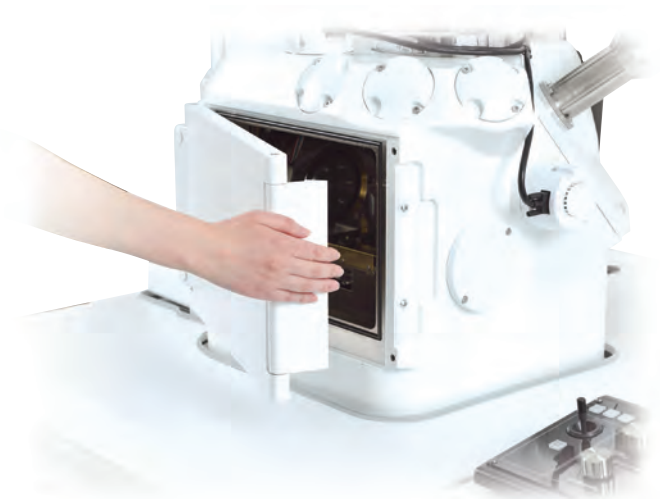

*The evacuation time depends on the room environment and specimen type or shape.

Maintenance

Filament

Filaments are pre-centered and require no centering by the operator.

Gun alignment

Fully automated gun alignment is built in.

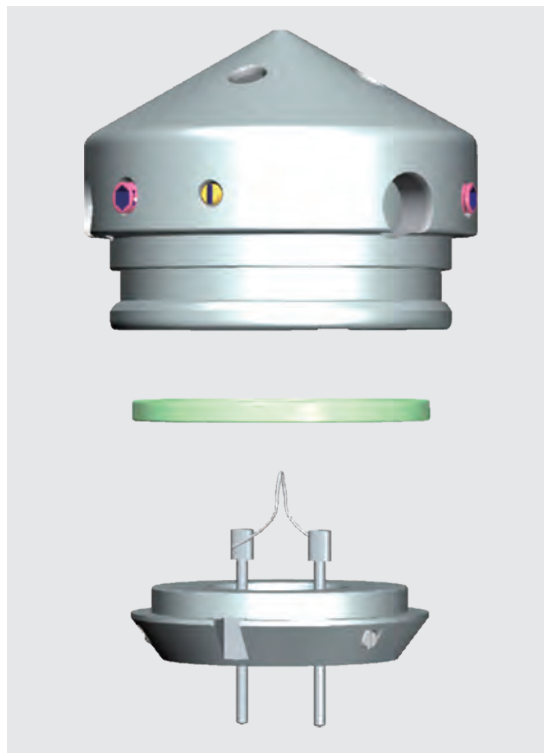

By simply inserting the filament into the Wehnelt and fixing it, the filament is automatically aligned to the center axis.

Help guide

The help guide, makes it easy to understand operation methods of SEM and EDS, as well as maintenance procedures. With this guide, novice users can quickly achieve results.

Help guide



Condition setting

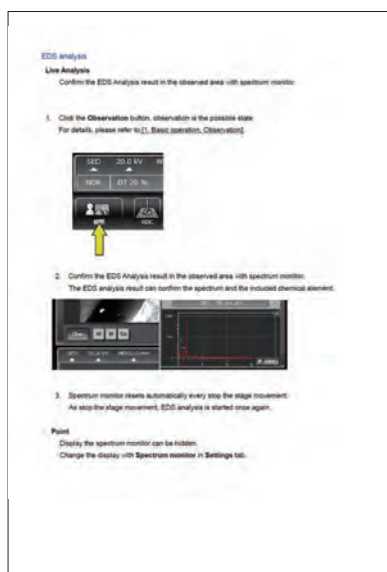

Analysis

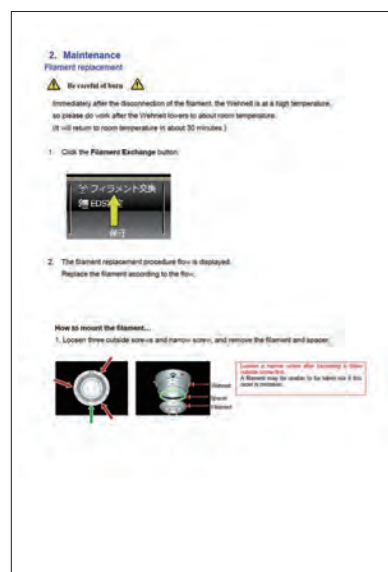

Maintenance

Analysis Examples of Foreign Materials, Comparison

Seamless analysis of foreign materials on a filter using JSM-IT500

When you use a JSM-IT500 equipped with a CCD camera*1, the use of Zeromag enables you to search the specimen area from the Live Analysis facilitates determination of foreign materials and also speeds up routine tasks.

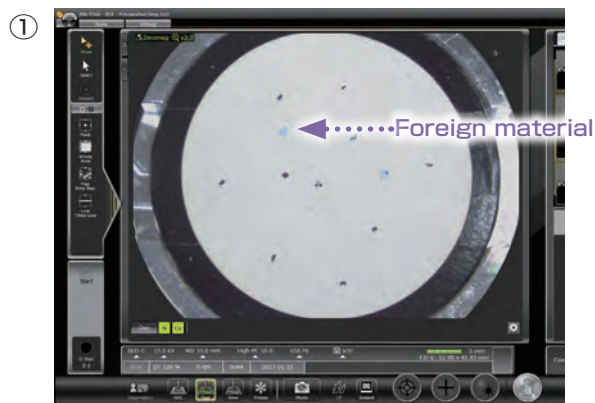

Acquire a CCD image*1 of the filter mounted on a 3-inch holder.



Magnify the CCD image*1 using Zeromag to confirm a foreign material.



(A) Click the Point icon button.
 (B) Click a foreign material on the SEM image.
 These steps set the analysis positions.



Repeat steps ① to ④ to set positions for analysis of all the foreign materials. When you click the Start button, automated multiple-area serial analysis is performed and the analysis results are stored.

Functions to facilitate observation and analysis

● Recipe function

This function allows for setting of SEM conditions automatically. Standard recipes enable you to set the conditions depending on the specimen type. Custom recipes enable you to save the conditions of routine tasks.

Observation example using the standard recipes



① Select a specimen area. In this image, plant leaves (biological specimen) is selected.



② Select a specimen type from the left screen. Next, check the specimen status, etc., in the right screen.

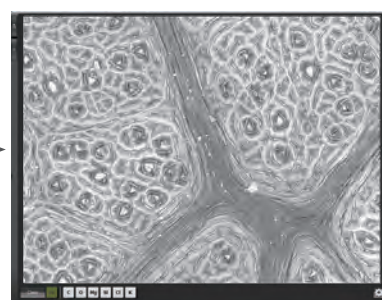

③ Appropriate conditions are automatically set and image is displayed.

Simple to Simple Analysis with Optical Microscope

color image.

*1 To take a CCD image, SNS (option) is required.

*2 Standard in the A/LA version.

③



Analyzes during observation.

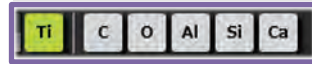

Main element display ⇒ An unexpected foreign material is confirmed.

Alert for an element of interest (yellow-green) ⇒ A foreign material containing an element of interest is confirmed.

- If an element of interest is not detected.▶ Return to ①. Move the SEM field to the next foreign material using Zeromag.
- Maximum load : 2 kg
- If an unexpected foreign material is found.▶ Proceed to ④.
- If an element of interest is detected.▶

When you **double-click the foreign material** to move it to the center of the Main screen, an SEM image is displayed and **Live Analysis*2 starts.**

⑥



After the completion of the analysis, **click the Data management button to display the Data management screen.** Select an analysis result from which you intend to generate a report and then, click the Report button.

⑦

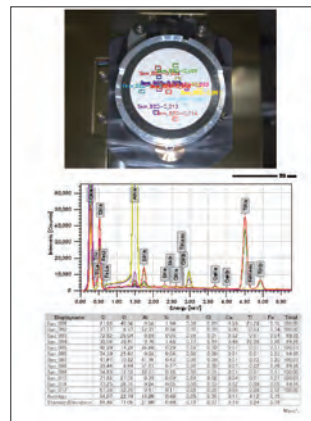

A report is automatically generated.

The operator can customize the layout of the report.

● Auto functions

The automatic functions enable you to observe images with simple operation. Single-click automatically adjusts Focus, Contrast, Brightness and Stigmator.

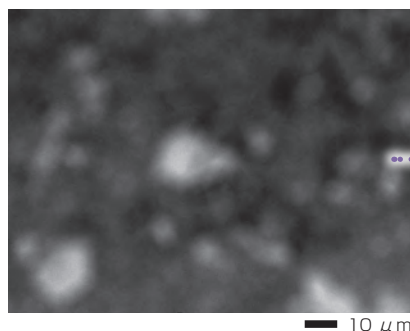

Auto

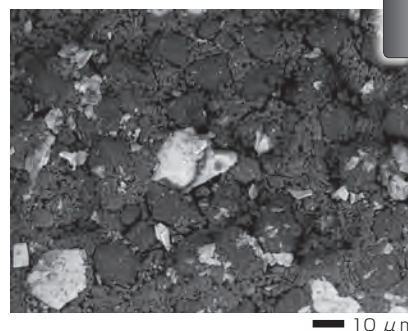

Photography



Specimen : Granule
Accelerating voltage : 7 kV
Direct magnification : × 1,000
High-vacuum mode
Backscattered electron composition image

Certain products in this brochure are controlled under the "Foreign Exchange and Foreign Trade Law" of Japan in compliance with international security export control. JEOL Ltd. must provide the Japanese Government with "End-user's Statement of Assurance" and "End-use Certificate" in order to obtain the export license needed for export from Japan. If the product to be exported is in this category, the end user will be asked to fill in these certificate forms.

ARGENTINA
 COASIN S.A.C.IyF.
 Virrey del Pino 4071,
 C1430CAM-Buenos Aires
 Argentina
 Tel. 54-11-4552-3185
 Fax. 54-11-4555-3321

AUSTRALIA & NEW ZEALAND
 JEOL(AUSTRALASIA) Pty.Ltd.
 Suite 1, L2 18 Aquatic Drive
 - Frenchs Forest NSW 2086
 Australia
 Tel. 61-2-9451-3855
 Fax. 61-2-9451-3822

AUSTRIA
 JEOL (GERMANY) GmbH
 Gute Aenger 30
 85356 Freising, Germany
 Tel. 49-8161-9845-0
 Fax. 49-8161-9845-100

BANGLADESH
 A.Q. CHOWDHURY SCIENCE & SYNERGY PVT. LTD.
 87, Suhrawardy Avenue, Floor 2
 Baridhara, Dhaka 1212
 Bangladesh
 Tel. 8802-9682272, 8953450, 8953501
 Fax. 8802-9854428

BELGIUM
 JEOL (EUROPE) B.V.
 Planet II, Gebouw B
 Luuvensteenteweg 542,
 B-1300 Zaventem
 Belgium
 Tel. 32-2-720-0560
 Fax. 32-2-720-6134

BRAZIL
 JEOL Brasil Instrumentos Cientificos Ltda.
 Av. Jabaquara, 2958 5° andar conjunto 52 ;
 04046-500 Sao Paulo, SP
 Brazil
 Tel. 55-11-5070 4000
 Fax. 55-11-5070 4110

CANADA
 JEOL CANADA, INC.
 3275 Tere Rue, Local #8
 53-Hubert, QC J3Y8Y6, Canada
 Tel. 1-450-676-8776
 Fax. 1-450-676-8694

CHILE
 ARQUIMED INNOVATION
 Arturo Prat 828,
 Santiago, Chile
 Tel. 56-2-634-6266
 Fax. 56-2-634-4633

CHINA
 JEOL(BEIJING) CO., LTD.
 Zhongkeziyuan Building South Tower 2F,
 Zhongguancun Nanshan Street No. 6,
 Haidian District, Beijing, P.R.China
 Tel. 86-10-6804-6321
 Fax. 86-10-6804-6324

JEOL (BEIJING) CO., LTD., SHANGHAI BRANCH
 Room 1505/1506, No. 3000X Kang Road,
 Jing an Dist., Shanghai, 200040, China
 Tel. 86-21-6249-4693/4487/4537/4404
 Fax. 86-21-6248-4075

JEOL (BEIJING) CO., LTD., GUANGZHOU BRANCH
 N1601, World Trade Center Building,
 #371-375, Huan Shi Road East, Guangzhou,
 Guangdong Prov., 510095, P.R.China
 Tel. 86-20-8778-7848
 Fax. 86-20-8778-4268

JEOL (BEIJING) CO., LTD., WUHAN BRANCH
 Room A2118, Zhongshang Plaza Office Bldg.,
 No. 7 Zhongnan Road, Wuhan,
 Hubei, 430071, P.R.China
 Tel. 86-27-8713-2567
 Fax. 86-27-8713-2567

JEOL LTD. (BEIJING) CO., LTD., CHENGDU BRANCH
 1807A Zongfu Building,
 NO. 35 Zhongfu Road, Chengdu, Sichuan, 610016
 P.R. China
 Tel. 86-28-86622554
 Fax. 86-28-86622564

EGYPT
 JEOL SERVICE BUREAU
 3rd Fl. Nile Center Bldg., Nawal Street,
 Dokki, (Cairo), Egypt
 Tel. 20-2-3335-7220
 Fax. 20-2-3339-1188

FRANCE
 JEOL (EUROPE) SAS
 Espace Claude Monet, 1 Allée de Giverny
 79280, Croissy-sur-Seine, France
 Tel. 33-13015-3737
 Fax. 33-13015-3747

GERMANY
 JEOL (GERMANY) GmbH
 Gute Aenger 30
 85356 Freising, Germany
 Tel. 49-8161-9845-0
 Fax. 49-8161-9845-100

GREAT BRITAIN & IRELAND
 JEOL (U.K.) LTD.
 JEOL House, Silver Court, Watchmead,
 Welwyn Garden City, Herts AL7 1LT, U.K.
 Tel. 44-1707-377117
 Fax. 44-1707-373254

GREECE
 N. ASTERADIS S.A.
 56-56,S, Tirkoupi Str. P.O. Box 26140
 GR-10022, Athens, Greece
 Tel. 30-1-823-5383
 Fax. 30-1-823-9567

HONG KONG
 FARMING LTD.
 Unit No. 1009, 10/F., Prosperity
 663 King's Road, North Point, Hong Kong
 Tel. 852-2815-7299
 Fax. 852-2581-4635

INDIA
 JEOL INDIA Pvt. Ltd.
 Unit No. 305, 3rd Floor,
 ABW Elegance Tower,
 Jasola District Centre,
 New Delhi 110 025, India
 Tel. 91-11-4672-2578
 Fax. 91-11-4060-1235

JEOL India Pvt. Ltd. Mumbai Branch
 Regus Mumbai
 Levels Ground & 1, Trade Centre Bandra Kurla Complex 1108,
 Bandra (E) Mumbai, 400051, India
 Tel. : +91-22-40700700

INDONESIA
 PT. TEKNOABINDO Penta Perkasa
 Komplek Gading Bukit Indah Blok 1/11
 Jl. Bukit Gading Raya Kelapa Gading Permai,
 Jakarta 14240, Indonesia
 Tel. 62-21-45847057/58
 Fax. 62-21-45842729

ITALY
 JEOL (ITALIA) S.p.A.
 Palazzo Piacentini - Milano 3 City,
 Via Ludovico il Moro, 6/A
 20090 Basiglio(MI) Italy
 Tel. 39-02-9041431
 Fax. 39-02-90414343

KOREA
 JEOL KOREA LTD.
 Dongwoong Bldg. 7F, 1443, Yangje Daero,
 Gangdong-Gu, Seoul, 05355, Korea
 Tel. 82-2-511-5801
 Fax. 82-2-511-2635

KUWAIT
 Ashraf & CO, Ltd.
 P.O.Box 3555 Safat 13036, Kuwait
 Tel. 965-1805151
 Fax. 965-24335373

MALAYSIA
 JEOL(MALAYSIA) SDN.BHD.
 508, Block A, Level 5,
 Kelana Business Center,
 97, Jalan SS 7/2, Kelana Jaya,
 47301 Petaling Jaya, Selangor, Malaysia
 Tel. 60-3-7492-7722
 Fax. 60-3-7492-7723

MEXICO
 JEOL DE MEXICO S.A. DE C.V.
 Arkansas 11 Piso 2
 Colonia Napoles
 Delegacion Benito Juarez, C.P. 03810
 Mexico D.F., Mexico
 Tel. 52-5-55-211-4511
 Fax. 52-5-55-211-0720

Middle East
 JEOL GULF FZE
 P.O. Box No. 371107
 Dubai Airport Free Trade Zone East Wing 5EA No. 404,
 Dubai, UAE
 Tel. 971-4-609-1497
 Fax. 971-4-609-1498

PAKISTAN (Karachi)
 ANALYTICAL MEASURING SYSTEM (PVT) LTD.(AMS LTD.)
 14-C Main Sehar Commercial Avenue Lane 4,
 Khayaban-e-Sehar,
 D.H.A-VII, Karachi-75500, Pakistan
 Tel. 92-21-35345581/35340747
 Fax. 92-21-35345582

PANAMA
 PROMED S.A.
 Parque Industrial Costa del Este
 Urbanizacion Costa del Este
 Apartado 0816-01755, Panama, Panama
 Tel. 507-303-3100
 Fax. 507-303-3115

PHILIPPINES
 PHILAB INDUSTRIES INC.
 7487 Bagtikan Street, SAV Makati,
 1203 Metro, Manila Philippines
 Tel. 63-2-896-8658
 Fax. 63-2-897-7732

PORTUGAL
 Izsasa Portugal Lda.
 R. do Proletariado, 1
 2790-138 CARNAXIDE, Portugal
 Tel. 351-21-424-73-00
 Fax. 351-21-418-60-20

RUSSIA
 JEOL (RUS) LLC.
 Krasnoproletskaya Street, 16,
 Bld. 2, 127473, Moscow,
 Russian Federation
 Tel. 7-495-748-7791/7792
 Fax. 7-495-748-7793

SAUDI ARABIA
 ABDULREHMAN ALGOSAIBI G.T.C. (Riyadh)
 Algosaiji Building-Old Airport Road
 P.O. Box 215, Riyadh-11411, Saudi Arabia
 Tel. 966-1-477-7932

SCANDINAVIA
 JEOL (Nordic) AB
 Hammarbacken 6A, Box 716, 191 27 Sollentuna
 Sweden
 Tel. 46-8-28-2800
 Fax. 46-8-29-1647

SINGAPORE
 JEOL ASIA PTE.LTD.
 2 Corporation Road
 #01-12 Corporation Place
 Singapore 618494
 Tel. 65-6565-9889
 Fax. 65-6565-7552

SOUTH AFRICA
 ADI Scientific (Pty) Ltd.
 370 Angus Crescent,
 Northlands Business Park, 29 Newmarket Road
 Northriding, Randburg, Republic of South Africa
 Tel. 27-11-462-1363
 Fax. 27-11-462-1466

SPAIN
 IZASA Scientific SLU,
 Argoneses, 13, 28108 Alcobendas,
 Madrid, Spain
 Tel. 34 902 20 30 80
 Fax. 34 902 20 30 81

SWITZERLAND
 JEOL (GERMANY) GmbH
 Gute Aenger 30
 85356 Freising, Germany
 Tel. 49-8165-77346
 Fax. 49-8165-77512

TAIWAN
 JIE DONG CO., LTD.
 7F, 112, Chung Hsiao East Road,
 Section 1, Taipei, Taiwan 10023 (R.O.C.)
 Tel. 886-2-2395-2978
 Fax. 886-2-2322-4655

For NMR & Mass Spectrometer Products
 Widelectron Technologies Corp.
 No.8-2, No.77, Sec.2, Zhonghua E Rd.,
 East Dist., Tainan City 701, Taiwan (R.O.C.)
 Tel. 886-6-289-1943
 Fax. 886-6-289-1743

(For Mass Spectrometer Products)
 Tech Max Technical Co. Ltd.
 5F, No.11, Wuqian 2nd Rd., Wugu Dist.,
 New Taipei City 248, Taiwan (R.O.C.)
 Tel. 886-2-8990-1779
 Fax. 886-2-8990-2559

For Semiconductor Products:
 JEOL TAIWAN SEMICONDUCTORS LTD.
 2F-2, No. 192, Dongguang Rd,
 East Dist., Hsinchu City 30066,
 Taiwan (R.O.C.)
 Tel. 886-3-571-5656
 Fax. 886-3-571-5151

THAILAND
 BECTHAI BANGKOK EQUIPMENT & CHEMICAL CO., Ltd.
 300 Phrayothin Rd, Phayathai, Bangkok 10400,
 Thailand
 Tel. 66-2-615-2929
 Fax. 66-2-615-2350/2351

JEOL ASEAN TECHNICAL CENTER (JATC)
 MTEC building room 533
 114 Moo9, Thailand Science Park
 Phrayothin Rd, Klong 1, Klong Luang,
 Pathumthani 12120
 THAILAND
 Tel. 66-2-564-7738
 Fax. 66-2-564-7739

THE NETHERLANDS
 JEOL (EUROPE) B.V.
 Lirweg 4, NL-2153 PH Nieuw-Vennep,
 The Netherlands
 Tel. 31-252-623500
 Fax. 31-252-623501

TURKEY
 Iksker A.S.
 Kartal Cad. No: 55/3 Inonu Wah,
 Atasehr 34755, Istanbul, Turkey
 Tel. 90-216-5736470
 Fax. 90-216-5736475

USA
 JEOL USA, INC.
 11 Osarton Road, Peabody, MA 01960, U.S.A.
 Tel. 1-978-535-5900
 Fax. 1-978-536-2205/2206

JEOL USA, INC. WEST OFFICE
 5653 Stoneridge Drive Suite #110
 Pleasanton, CA 94588, U.S.A.
 Tel. 1-925-737-1740
 Fax. 1-925-737-1749

VENEZUELA
 GOMISA Service and Supply C.A.
 Urbanization Montalban III
 - Residencias Don Andres - Piso 7 - Apartamento 74
 Avenida 3, entre calles 7 y 6
 Montalban, Caracas, Venezuela
 Tel. 58-212-443-4342
 Fax. 58-212-443-4342

Vietnam
 TECHNICAL MATERIALS AND RESOURCES
 IMPORT-EXPORT JOINT STOCK COMPANY(REXCO)
 Hanoi Branch
 No. 13-Lot 12 Trung Yen, Trung Hoa Street,
 Cau Gay Dist, Hanoi, Vietnam
 Tel. 84-43-562-0516
 Fax. 84-43-853-2511