



CNC Video Measuring System
iNEXIV VMA Series

CNC Video Measuring System

iNEXIV VMA Series

Reaching the peak of
video measuring systems

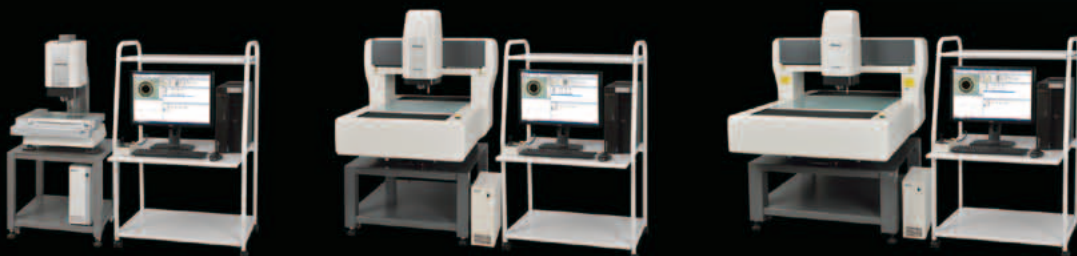
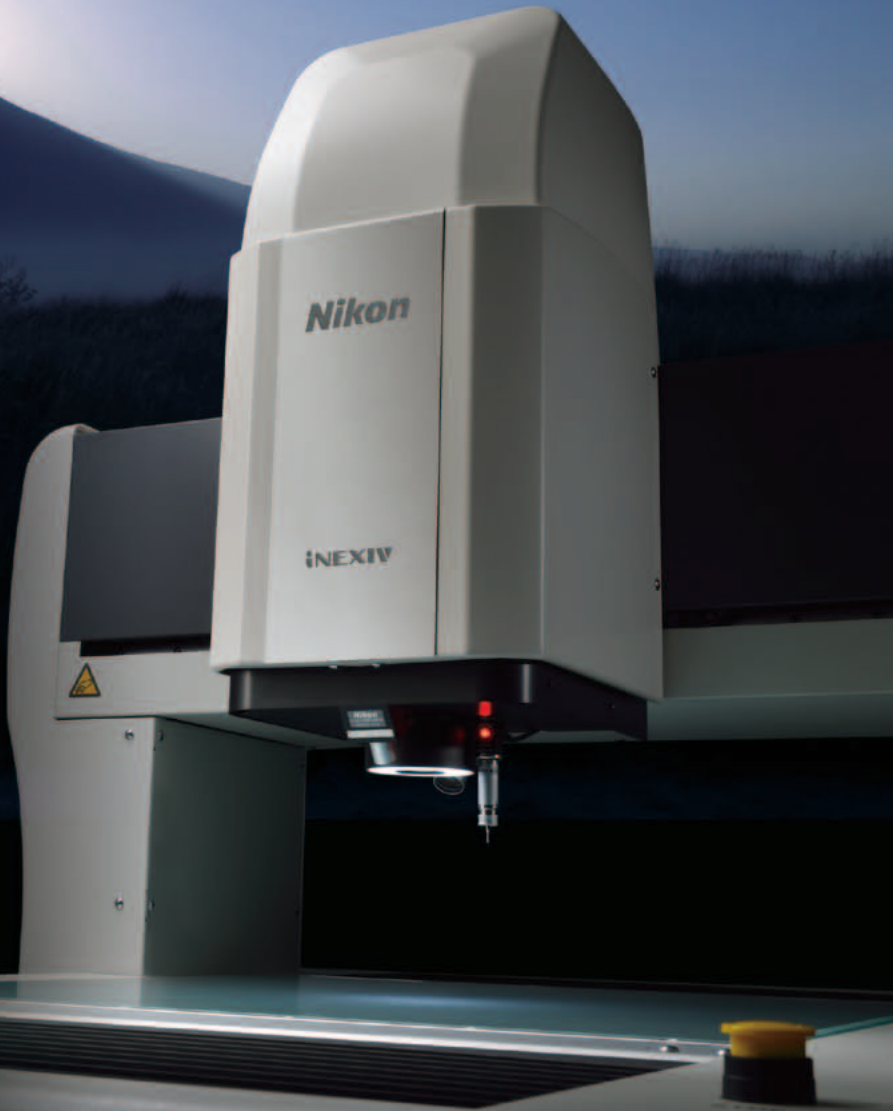

Aiming for new heights, Nikon offers the ultimate in usability for a wide variety of measuring applications with the large FOV, long XYZ stroke iNEXIV VMA series.

iNEXIV VMA Series

Nikon CNC video measuring system iNEXIV VMA automatically measures various components, such as mechanical, plastic injection-molded and electronic parts, with high accuracy and repeatability.

The wide actual field of view of maximum 13 mm (W) x 10 mm (H) at the lowest magnification enables easy confirmation of measurement points.

In addition, the 73.5 mm-working-distance objective lens and extended 200 mm Z-axis stroke allows measurements of tall and uneven objects with the very little possibility of collision between the objective lens and samples.

Three models in the iNEXIV VMA series are available, each with a different XY-stroke.

A touch probe version of each model is also available.

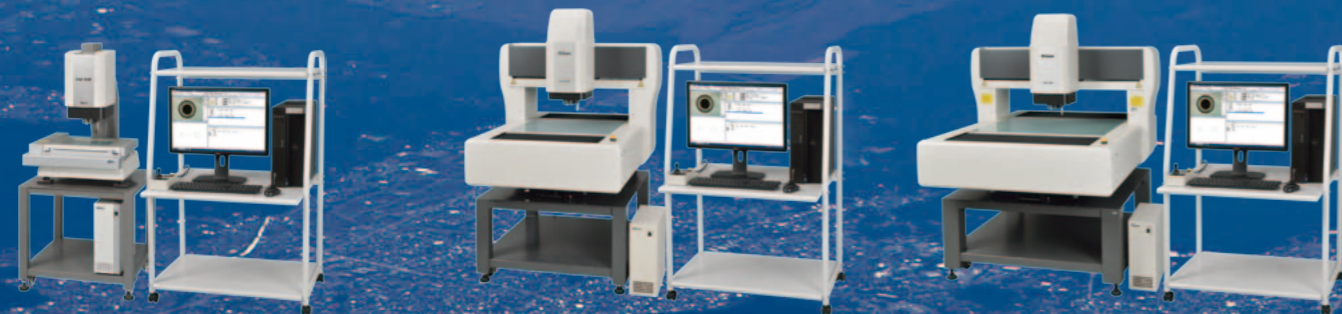

Standard stroke model

250 (X) x 200 (Y) x 200 (Z) mm

iNEXIV VMA-2520V/ VMA-2520

A space-saving, low-cost model that is suited to measurement of small parts

Middle stroke model

450 (X) x 400 (Y) x 200 (Z) mm

iNEXIV VMA-4540V/ VMA-4540

For measurement of a wide range of objects, such as molded and pressed parts

Large stroke model

650 (X) x 550 (Y) x 200 (Z) mm

iNEXIV VMA-6555V/ VMA-6555

For measurement of large samples and simultaneous measurement of multiple parts

* The touch probe can only be attached to the VMA-2520/4540/6555, and not to the VMA-2520V/4540V/6555V

Wide field of view and sharp, clear images

A wide FOV of up to 13 mm x 10 mm (at 0.35x) allows easy search and alignment of measuring targets. The 10x zoom with five specific steps provides accurate measurement as well as high-resolution images. An excellent Apochromat objective lens with high NA (0.11) and low distortion has been specially designed for the iNEXIV series, providing crisp, clear images.



Sample: Ø23.5 mm coin

Optical magnification		0.35x	0.6x	1x	1.8x	3.5x
FOV size on stage	Horizontal x vertical (mm)	13.3 x 10.0	7.8x 5.8	4.7x 3.5	2.6x 1.9	1.33x 1.00
	1/3" CCD size	Horizontal x vertical (mm) 4.8x3.6				
Video magnification	36					
Total magnification on video window (640 x 480 pixels)*		12.6	21.6	36	64.8	126
Pixel size (µm)		21.8	12.6	7.36	4.25	2.15
Size of objects on video window (640 x 480 pixels)	0.01x (mm)	0.126	0.216	0.36	0.648	1.26
	1x (mm)	12.6	21.6	36	64.8	126

* On a 24-inch WUXGA (1920 x 1200 pixels) monitor, recommended for the VMA series.

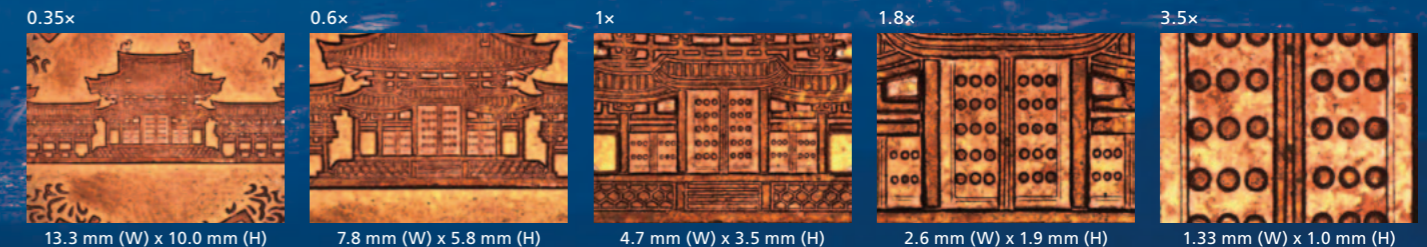

Robust 73.5 mm working distance

A long 73.5 mm working distance minimizes the possibility of contact between the objective lens and valuable parts. It is ideal for measuring large step heights, tall bosses and deep holes.

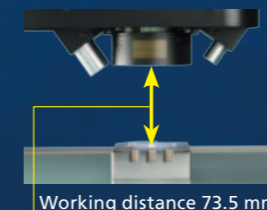

Large XY stroke and long Z stroke

Three models with different XY strokes are available to suit user requirements; 250 x 200 mm, 450 x 400 mm and 650 x 550 mm. The three models enable measurements of various samples, ranging from small parts to large PCBs and panels, and also long parts and simultaneous measurements of multiple parts. An extended 200 mm Z-axis stroke is perfect for tall workpieces.

Tools for realizing non-stop automatic measurement

Fast and accurate vision AF (Auto Focus)

The iNEXIV VMA series is equipped with highly repeatable vision AF that offers high-speed, high-precision focusing and height/depth measurement. Non-contact measurement using vision AF does not damage or deform parts, and does not necessitate fixing.

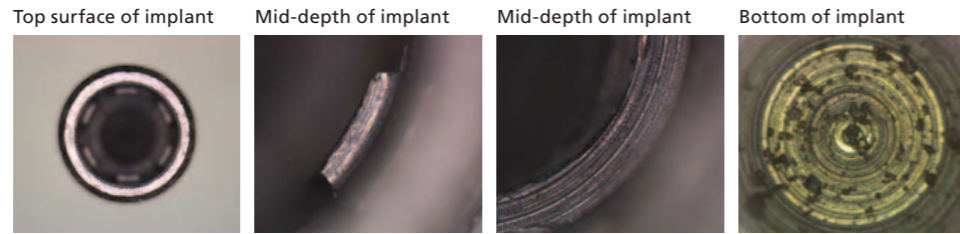

Even the bottom of a small diameter hole can be brought into correct focus.

Laser AF (option)

The Laser AF with a long 63 mm working distance is optionally available, enabling height measurement of flat surfaces with high repeatability, in keeping a wide FOV at a low magnification.

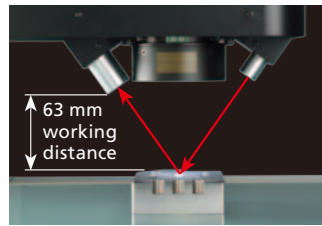

Versatile illuminations

The iNEXIV VMA series is equipped with episcopic (top), diascopic (bottom) and 8-segment ring (with 18-degree oblique angle) LED illuminators. Combining these illuminators with superior optics provides accurate detection of low contrast edges.

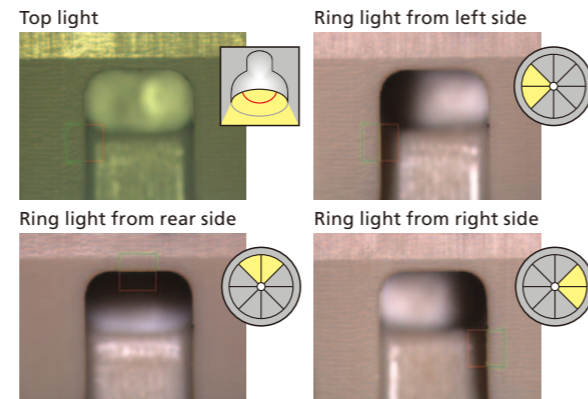

Any 8-segment light can be selected for effective edge detection.

Intelligent search



Recorded image

Even when a workpiece is misaligned, the system automatically searches the target location based on the target image recorded in a teaching file, enabling accurate, automatic measurement by eliminating possible detection errors.

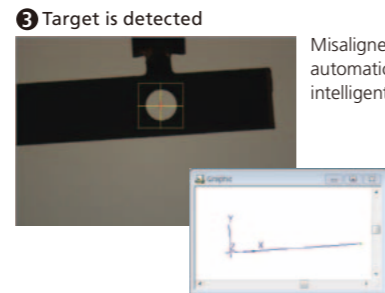
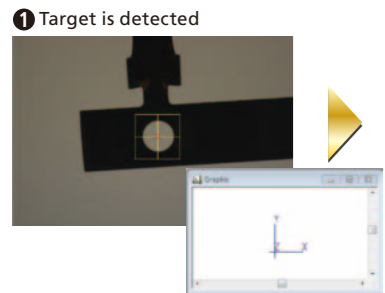

Misaligned target can be automatically detected using intelligent search

XY coordinate

XY coordinate after searching the target

Digital chart comparator

Deviation of contours can be checked by overlaying charts generated digitally from 2D CAD data onto video images. Digital charts always accompany video images.

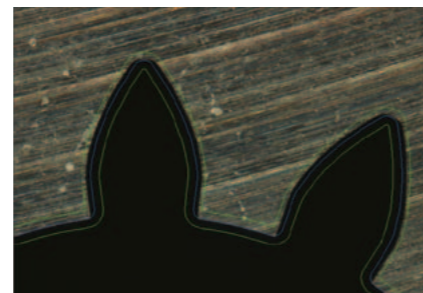

Options for expanding measurement possibilities

Touch probe for measurement of imperceptible parts from top and bevel angle (option)

The VMA-2520/4540/6555 is touch-probe ready and accommodates optional Renishaw® TP20 or TP200 touch probes. Touch probes provide measurements of 3D shapes parts where vision AF cannot be used, such as the inner diameter of an oil seal or the clearance angle of an indexable insert. The touch probe offsets from the optical axis, but works coaxially in the same XYZ coordinate system as the optical axis using iNEXIV VMA TP AutoMeasure software.

* The VMA-2520V/4540V/6555V is only for video measuring.

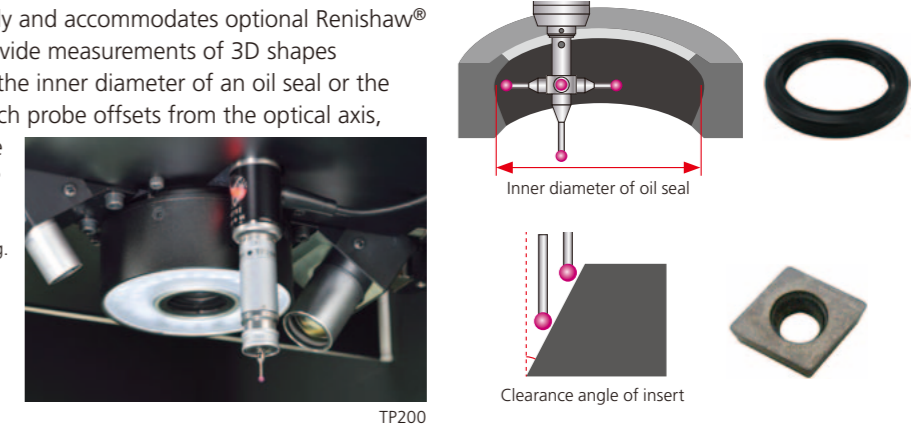

TP200

Extended 1.5x high-magnification (option)

Each model can be modified before shipment to extend magnification to 1.5x, powerful enough for precise measurement of minute electronic parts.

* Video measuring images are slightly darker with the 1.5x high-magnification option, even with the same light intensity setting (0 - 100).

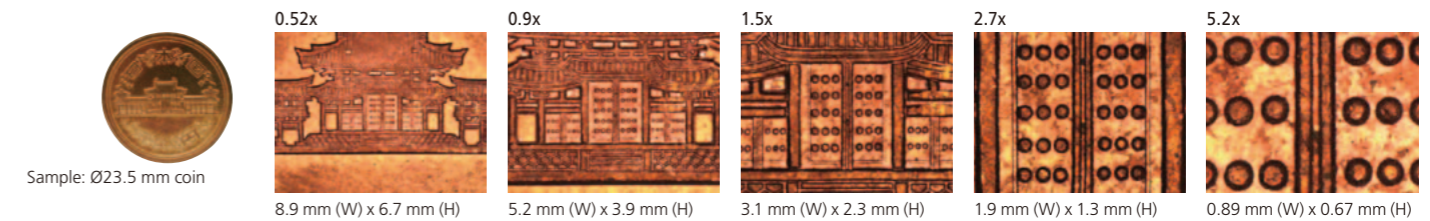

Sample: Ø23.5 mm coin

8.9 mm (W) x 6.7 mm (H)

5.2 mm (W) x 3.9 mm (H)

3.1 mm (W) x 2.3 mm (H)

1.9 mm (W) x 1.3 mm (H)

0.89 mm (W) x 0.67 mm (H)

Dedicated software to meet measurement requirements

User-friendly standard software iNEXIV VMA AutoMeasure

The VMA AutoMeasure software provides enhanced ease of use and versatility based on Nikon's years of extensive experience in developing the NEXIV series.

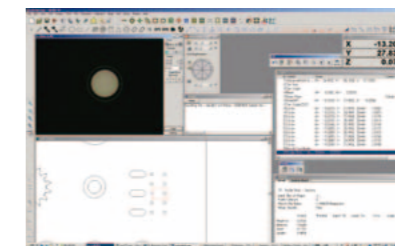

Main program layout

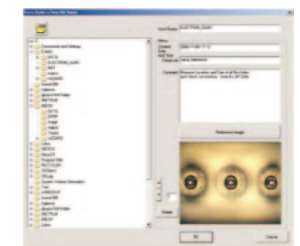

Teaching file selection with interactive guides

Optional software

iNEXIV VMA Profiler/CAD Reader: 2D profile shape analysis program

iNEXIV VMA Virtual AutoMeasure: CAD interface off-line teaching support program

Gear evaluation software: Analysis of flat gears in terms of pitch deviations, tooth profile errors, tooth space run out, base tangent length, dimension over pin

NEXIV EDF/Stitching Express: Image analysis and archiving program for creating an all-in-focus EDF (Extended Depth of Focus) image from multiple images at different Z axis. This also generates a stitched image with super wide FOV from multiple images on the same XY plane.

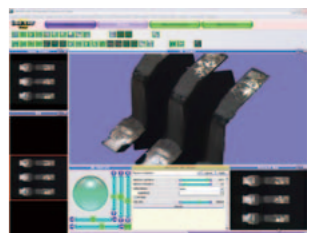

NEXIV EDF/Stitching Express

Three models with different XYZ strokes to suit various sample sizes

Standard stroke model

INEXIV VMA-2520V

(video measuring)

INEXIV VMA-2520

(video and touch probe measuring*)

Stroke	250 (X) x 200 (Y) x 200 (Z) mm
Measuring head travel	Z direction (single column type)
Stage travel	X-Y direction



High-performance, compact and affordable model that is suitable for small samples (within 250 x 200 x 200 mm)

Top view of stage

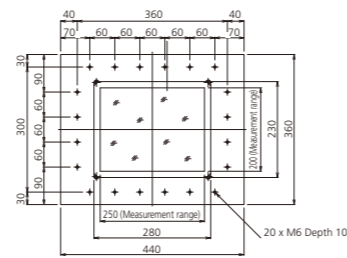

Dimensional diagram

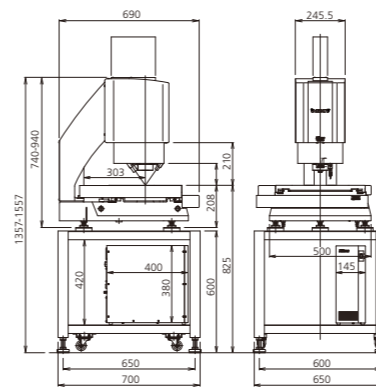

Measurement range with TP20 with 10 mm stylus (without MCR20)

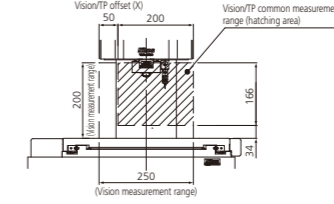

(with MCR20)

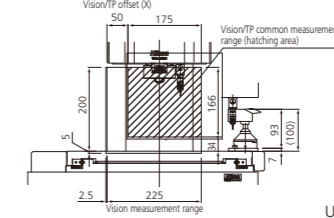

Unit: mm

PC rack (for all models)

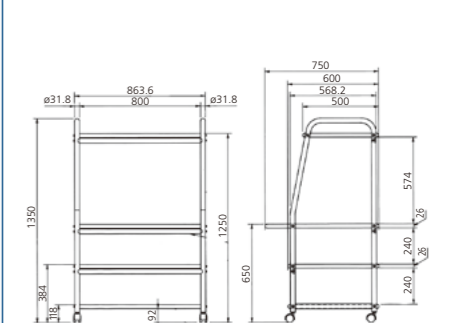

Unit: mm

Middle stroke model

INEXIV VMA-4540V

(video measuring)

INEXIV VMA-4540

(video and touch probe measuring*)

Stroke	450 (X) x 400 (Y) x 200 (Z) mm
Measuring head travel	X-Y direction (bridge type)
Stage travel	Y direction

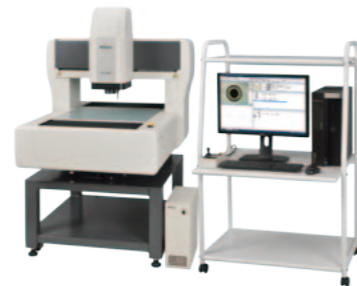

Suitable for midsize samples (250 x 200 x 200 mm – 450 x 400 x 200 mm) and simultaneous measurement of multiple small parts. High cost-performance with the same strong cast-iron body and direct bearing as the top-end model in the NEXIV VMZ-R series.

Top view of stage

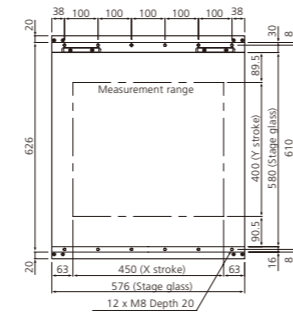

Dimensional diagram

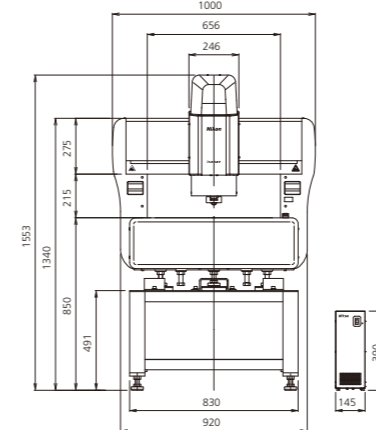

Measurement range with TP20 with 10 mm stylus

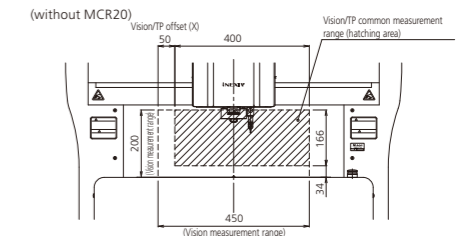

(with MCR20)

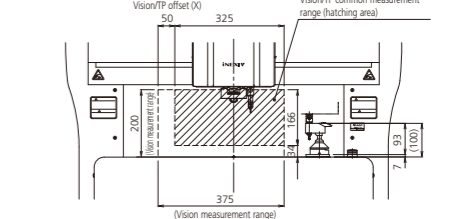

Unit: mm

Large stroke model

INEXIV VMA-6555V

(video measuring)

INEXIV VMA-6555

(video and touch probe measuring*)

Stroke	650 (X) x 550 (Y) x 200 (Z) mm
Measuring head travel	X-Y direction (bridge type)
Stage travel	Y direction



Suitable for large samples (450 x 400 x 200 mm or larger) and simultaneous measurement of multiple parts. High cost-performance with the same strong cast-iron body and direct bearing as the top-end model in the NEXIV VMZ-R series.

Top view of stage

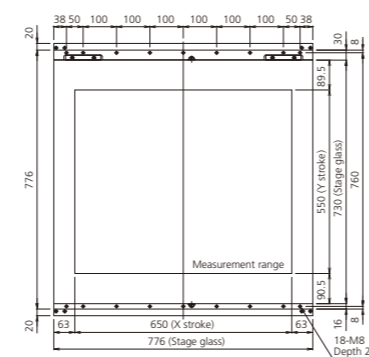

Dimensional diagram

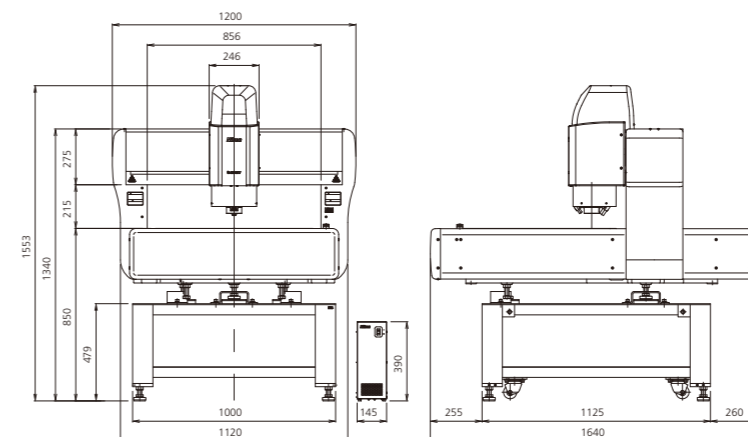

Measurement range with TP20 with 10 mm stylus

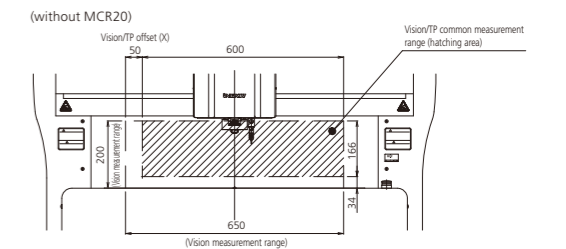

(with MCR20)

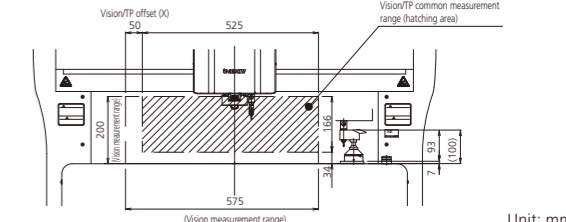

Unit: mm

* The touch probe can only be attached to the VMA-2520/4540/6555, and not to the VMA-2520V/4540V/6555V

Specifications

Main body	iNEXIV VMA-2520V/2520	iNEXIV VMA-4540V/4540	iNEXIV VMA-6555V/6555
Stroke (X x Y x Z)	250 x 200 x 200 mm	450 x 400 x 200 mm	650 x 550 x 200 mm
Measurement range with TP (Touch Probe)*1	200 x 200 x 166 mm (TP20) 200 x 200 x 170 mm (TP200) 250 x 200 x 200 mm (with Vision AF)	400 x 400 x 166 mm (TP20) 400 x 400 x 170 mm (TP200) 450 x 400 x 200 mm (with Vision AF)	600 x 550 x 166 mm (TP20) 600 x 550 x 170 mm (TP200) 650 x 550 x 200 mm (with Vision AF)
Measurement range with TP & MCR20*2	175 x 200 x 166 mm (TP20) 175 x 200 x 170 mm (TP200) 225 x 200 x 200 mm (with Vision AF)	325 x 400 x 166 mm (TP20) 325 x 400 x 170 mm (TP200) 375 x 400 x 200 mm (with Vision AF)	525 x 550 x 166 mm (TP20) 525 x 550 x 170 mm (TP200) 575 x 550 x 200 mm (with Vision AF)
Minimum readout	0.1 µm		
Maximum workpiece weight	15 kg	40 kg	50 kg
Maximum workpiece weight (accuracy guaranteed)	5 kg	20 kg	30 kg
Maximum permissible error*3 EUX,MPE EUY,MPE EUX,MPE EUY,MPE EUL,MPE (L = Length in mm)	2+8L/1000 µm 3+8L/1000 µm 3+L/50 µm	2+6L/1000 µm 3+6L/1000 µm 3+L/100 µm	
Camera	1/3-in. progressive scan b/w camera (standard), 1/3-in. progressive scan color camera (optional)		
Working distance	73.5 mm (63 mm with Laser AF)		
Magnification	Optical: 0.35 to 3.5x (0.52x to 5.2x high magnification is available as an option) On screen: 12.6 to 126x with 24-inch WUXGA (1920 x 1200 pixels) monitor		
FOV size on stage	13.3 x 10 mm to 1.33 x 1 mm (8.9 x 6.7 mm to 0.89 x 0.67 mm with high-magnification option)		
Auto focus	Vision AF and optional Laser AF		
Illumination Contour illumination Surface illumination Oblique illumination	White LED diascopic illumination White LED episcopic illumination 8-segment white LED ring illumination		
Video resolution	640 x 480 (pixels)		
Touch probe (optional) *1	Renishaw® TP200/TP20		
Power source	100V-240 V, 50/60 Hz		
Power consumption	5A(100V) - 2.5A(240V)		
Dimensions & weight Main body with table (W x D x H) Controller	650 x 700 x 1557 mm, 110 kg 145 x 400 x 390 mm, 14 kg	1000 x 1340 x 1553 mm, 500 kg 145 x 400 x 390 mm, 14 kg	1200 x 1640 x 1553 mm, 665 kg 145 x 400 x 390 mm, 14 kg
Operational environment Temperature Humidity	10°C to 35°C 70% or less		
Accuracy guaranteed temperature	20°C ±0.5K		
Host computer			
CPU	Intel® Core™2 Duo CPU or faster		
Memory	4GB or more		
OS	Windows® 7 32bit		
Interface	USB2.0 / IEEE1394		

*1 The touch probe can only be attached to the VMA-2520/4540/6555, and not to the VMA-2520V/4540V/6555V.

*2 The iNEXIV-dedicated MCR20 can be used for both TP20 and TP200.

*3 Nikon's in-house test at 20°C ±0.5k

Laser AF is a Class 1 Laser Product

CLASS 1 LASER PRODUCT

N.B. Export of the products* in this catalog is controlled under the Japanese Foreign Exchange and Foreign Trade Law. Appropriate export procedure shall be required in case of export from Japan. *Products: Hardware and its technical information (including software)

Specifications and equipment are subject to change without any notice or obligation on the part of the manufacturer. July 2014 ©2014 NIKON CORPORATION

 WARNING	TO ENSURE CORRECT USAGE, READ THE CORRESPONDING MANUALS CAREFULLY BEFORE USING YOUR EQUIPMENT.
---	--

Company names and product names appearing in this brochure are their registered trademarks or trademarks.



NIKON CORPORATION

Shin-Yurakucho Bldg., 12-1, Yurakucho 1-chome, Chiyoda-ku, Tokyo 100-8331, Japan
phone:+81-3-3216-2384 fax:+81-3-3216-2388
<http://www.nikon.com/instruments/>



ISO 9001 Certified
for NIKON CORPORATION
Instruments Company



ISO 14001 Certified
for NIKON CORPORATION

NIKON METROLOGY, INC.

12701 Grand River Avenue, Brighton, MI 48116 U.S.A.
phone: +1-810-220-4360 fax: +1-810-220-4300
E-mail: Sales.US.NM@nikon.com
<http://us.nikonmetrology.com/>
<http://www.nikoninstruments.com/>

NIKON METROLOGY EUROPE NV

Geldenaaksebaan 329, 3001 Leuven, Belgium
phone: +32-16-74-01-00 fax: +32-16-74-01-03
E-mail: Sales.Europe.NM@nikon.com
<http://www.nikonmetrology.com/>

NIKON INSTRUMENTS (SHANGHAI) CO., LTD.

CHINA phone: +86-21-6841-2050 fax: +86-21-6841-2060
(Beijing branch) phone: +86-10-5831-2028 fax: +86-10-5831-2026
(Guangzhou branch) phone: +86-20-3882-0552 fax: +86-20-3882-0580

NIKON SINGAPORE PTE LTD

SINGAPORE phone: +65-6559-3618 fax: +65-6559-3668

NIKON MALAYSIA SDN BHD

MALAYSIA phone: +60-3-7809-3688 fax: +60-3-7809-3633

NIKON INSTRUMENTS KOREA CO., LTD.

KOREA phone: +82-2-2186-8400 fax: +82-2-555-4415

NIKON INDIA PRIVATE LIMITED

INDIA phone: +91-124-4688500 fax: +91-124-4688527

NIKON INSTRUMENTS S.p.A.

ITALY phone: +39-055-300-96-01 fax: +39-055-30-09-93

NIKON METROLOGY UK LTD.

UNITED KINGDOM phone: +44-1332-811-349 fax: +44-1332-639-881
E-mail: Sales.UK.NM@nikon.com

NIKON METROLOGY SARL

FRANCE phone: +33-1-60-86-09-76 fax: +33-1-60-86-57-35

E-mail: Sales.France.NM@nikon.com

NIKON METROLOGY GMBH

GERMANY phone: +49-6023-91733-0 fax: +49-6023-91733-229

E-mail: Sales.Germany.NM@nikon.com