



Digital Imaging &  
Multi-sensing Metrology



CNC Video Measuring System

# iNEXIV

## VMA-2520





Electron gun

Designed to meet the automated metrology requirements of mechanical parts, electronic devices, dies & molds and medical devices

Metal press parts



# Digital Imaging & Multi-Sensing Metrology



## VMA-2520

The new iNEXIV VMA-2520 has been expressly designed for three-dimensional workpieces. Though compact and lightweight in design, it provides a long 200mm Z-axis stroke and a 73.5mm working distance, enabling easy Z-axis measurement of mechanical parts, plastic injection molding parts, metal press parts, electronic devices, dies & molds and medical devices. The standard 10x zoom optics meets the industry's demanding needs for superb resolution at high magnifications while offering a wide field of view at low magnifications. Low distortion optics and high intensity white LED illumination sources improve contrast to enhance throughput. This combination assures reproducible measurements even for colorful parts.



Connector

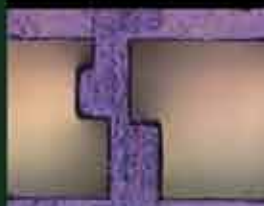

Plastic injection molding parts



## Main features

### Easy and accurate measurements optimized for 3D parts

Nikon has drawn on its state-of-the-art digital technologies to produce a highly affordable automated measurement system. The iNEXIV VMA-2520's design is optimized for easy use as well as repeatable and accurate measurement of 3D parts.

### Compact and lightweight

The iNEXIV VMA-2520 is a powerful bench top system designed to use minimum factory floor space. The main body has a footprint of only 565mm W x 690mm D x 740mm H (computer and controller separate) and weighs only 72kg (158.7 lb), yet it still has a 250mm x 200mm x 200mm measuring capability.

### Long working distance

The newly developed optical system features a super long 73.5mm working distance for all magnifications. This allows sufficient three dimensional clearance for Z-axis measurements even at high magnification.



Plastic injection molding parts



### High-speed, highly-accurate Laser AF (optional)

In addition to the standard Vision AF, an optional high-speed Laser AF with a long 63mm working distance is available. It provides Z-axis height measurements at the constant accuracy regardless of the optical magnification.

### Touch Probes / 3D CAD Off-line Programming (optional)

The iNEXIV VMA-2520 with the Renishaw TP20/TP200 Touch Trigger Probing system extends 3D parts measurement ability. Also, the new 3D CAD Off-line Program, 3D Metrology simulator makes the TP programming much easier.

### Sophisticated VMA AutoMeasure software

This new VMA AutoMeasure is an evolution of our well-established industry-standard Metrology software for the NEXIV VMR Series. It provides various functions to easily conduct tasks ranging from setup, teaching programs and measurements, to evaluations.

### EDF/Stitching Image Processing & Point Cloud Inspection (Optional)

The iNEXIV VMA-2520 captures EDF - Extended Depth of Field - and Stitching images. The optional software EDF/Stitching Express works seamlessly for the digital image archiving and even for the point cloud data export, which can be analyzed with the 3D CAD Inspection / Reverse Engineering Software.

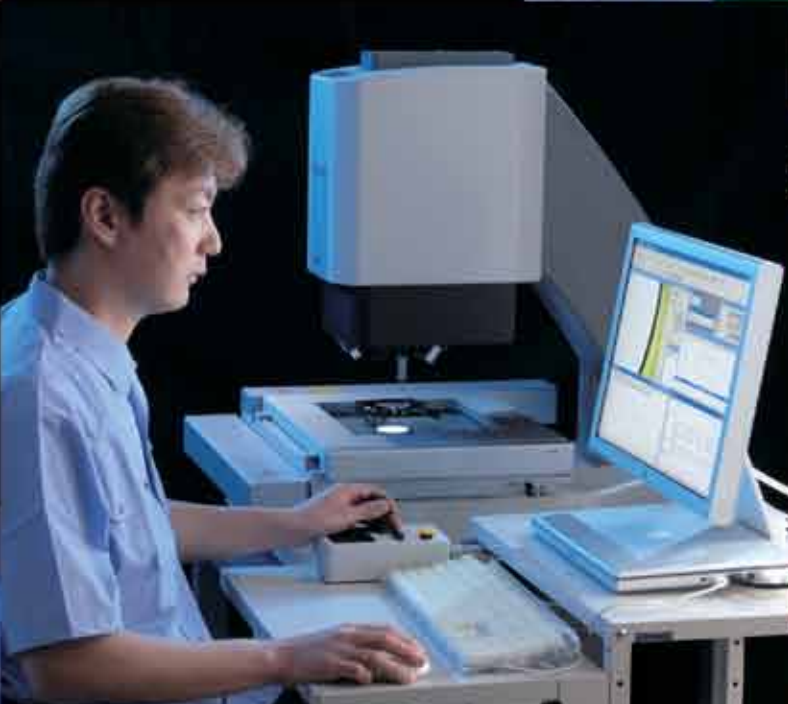

Aluminum die casting parts



3D CAD Inspection  
- SLR Camera Cover

Dual Spur Gear EDF Image with 2D CAD Chart



Drill Bits Stitched EDF Image



# Compact, lightweight design offering an extended measurement height



## Compact, space-saving body weighing 72kg

The VMA-2520 features a space-saving design with a footprint of just 2000 x 1000mm (main body & PC rack space). Although the body has a compact design and a height of only 740mm (min), it is capable of achieving a long 200mm Z-axis stroke, and because its structure is composed of aluminum-alloy materials, it only weighs 72kg (158.7 lb).

## Long 200mm Z-axis stroke plus 250mm x 200mm XY stroke

The VMA-2520 has a unique extendable optical head design that provides a Z-axis stroke of 200mm. Couple this with an X-Y stage travel of 250mm x 200mm and you have a system making measurements of 3D parts such as injection molding parts, metal parts, electronic devices, molds and medical devices easier to manage.

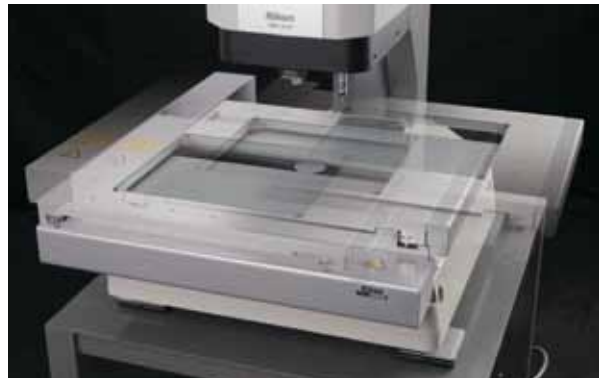

## High accuracy

By employing aluminum-alloy materials in its construction, pitch and yaw deviations caused by temperature fluctuations have been minimized. This, combined with the fast, highly accurate stage controls, increases both measurement accuracy and yield.

XY MPE<sub>E1</sub>: 2+8L/1000μm

XY MPE<sub>E2</sub>: 3+8L/1000μm

Z MPE<sub>E1</sub>: 3+L/50μm

## Easy setup

Only an IEEE1394 port and a USB2.0 port are required to connect a host computer to the iNEXIV controller. In addition, Nikon's new image processing technology eliminates the need for a frame grabber.



USB2.0 port

IEEE1394 port

Table for the main body and PC rack are optional

## New zooming optics make 3D parts measurements easier

Newly designed optics with an Apochromat LWD objective lens

Nikon has developed a new optical system that covers low magnifications, has a long working distance and is suitable for measuring three-dimensional parts. The Apochromat objective lens features low distortion (0.1% or less) while providing a long 73.5mm working distance throughout all magnification ranges. Moreover, improvements in the LED illumination system also increase image contrast by utilizing an Apochromatic lens to compensate for the blue wavelengths emitted from white LEDs.

10x zoom with wide field of view

The VMA-2520 comes standard with a five-step, 10x zoom optical system that provides both superb resolution at high magnification and a wide field of view at low magnification. Greater position accuracy, achieved by eliminating backlash in the zooming mechanism when using the five-step zoom range, makes it ideal for measurement applications.



Optical magnification	0.35x	0.6x	1x	1.8x	3.5x
Magnification on screen (with 17" monitor at SXGA resolution)	12x	20x	34x	62x	120x
Field of view	13.3 x 10mm	7.8 x 5.8mm	4.7 x 3.5mm	2.6 x 1.9mm	1.33 x 1mm

## White LED illumination for fast, high-accuracy measurement



### 8-segment LED ring illumination

This illumination system can be controlled from eight different directions. The white LED light with an average incidence angle of 18° makes possible observations of extremely low-contrast edges which are usually invisible under episcopic illumination. It is effective for measuring molds, medical devices and other three-dimensional parts.

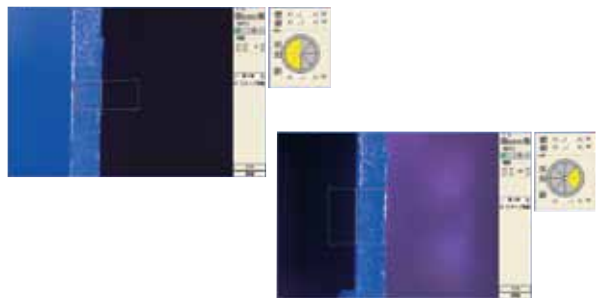

### High-intensity white LED light source for all illumination systems

The VMA-2520 employs a white LED light source for episcopic illumination, diascopic illumination and 8-segment LED ring illumination. The high-intensity white LED features constant color temperature and less flicker, thus it provides stable measurement accuracy, particularly when observing color images. With the LED's quick response to lighting controls, increased measurement throughputs can be achieved.

### Episcopic and diascopic illuminations

Both episcopic and diascopic illuminations employ a white LED light source that provides high-intensity closer to that of a halogen lamp. For the episcopic illumination, which previously did not use a white LED light source, the VMA-2520 employs the first flyeye integrator in a measuring system, realizing both sufficient NA and uniform illumination over a wide field of view. The diascopic illumination uses a white LED array, backlight system.

# Multiple sensors for high speed and accurate height detection - Vision, Laser and Touch Probe

## Optically independent Laser AF (option)

As well as the standard Vision AF, fast Laser AF that features a long 63mm working distance can be used as an option. The Laser AF for the VMA-2520 employs a non-contact sensor that uses a red semiconductor laser light as a fill light, and enables height detection with sub-micrometer resolution. The Laser AF provides fast and precise focusing on workpiece surfaces regardless of optical magnification, making measuring the height of workpieces easier.

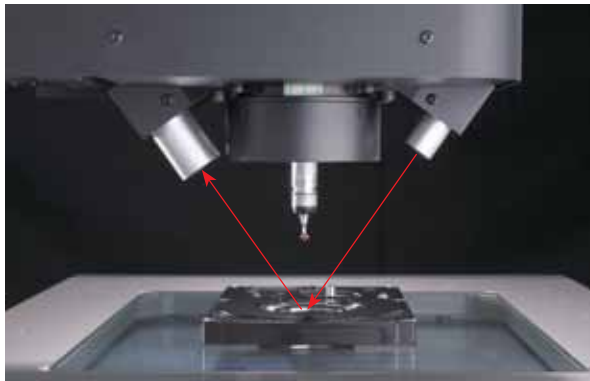

## High-speed, high-precision Vision AF

Thanks to the adoption of a new algorithm and a progressive scan CCD camera, Vision AF now provides greater speeds and accuracy. Vision AF is convenient for applications such as focusing surface and edges of a workpiece.

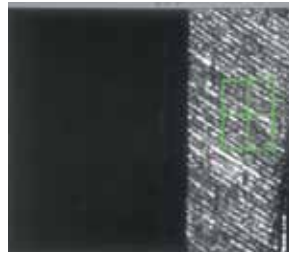

Surface focus



Contrast focus

## Touch probe for height and side measurements expand measuring area (option)

The iNEXIV VMA-2520 accepts the Renishaw® TP20 or TP200 Touch Trigger Probing system, making contact-probing measurements possible. It detects surface and side coordinates for complicated 3D parts, where vision sensing cannot be used. A single part measurement program can incorporate Vision, Laser and Touch Probing to realize multi-sensing metrology in the common datum plane.

The TP20 is a kinematic touch trigger probe. The two-piece design comprises a probe body and detachable stylus module(s) that can automatically change stylus configurations.

The TP200 is an electronic probe that uses strain gauge technology, which provides higher accuracy than kinematic touch trigger probes. The TP200 system components are the TP200 probe body, stylus module and PI200 probe interface.



Renishaw® TP200 Touch Trigger Probing system



Renishaw® TP200 & PI200 Probe Interface



MCR20 Module Changing Rack  
Renishaw® is a registered trademark of Renishaw plc.

The Probe Module Changing Rack MCR20 customized for iNEXIV is also available as an option. The MCR20 is designed to securely store different stylus modules ready for rapid automatic changing.

For attachment of styli that are longer than 20mm or star-type styli, please consult Nikon, authorized dealers or distributors.



Optional TP Interface controls up to 3 modules including five star styli. Please consult Nikon for appropriate stylus selection.



Calibration sphere and ring gauge set included in the basic set



The iNEXIV Training Part (option) is perfectly designed for the purpose of comprehensive multi-sensing metrology training. 2D/3D CAD data and a GD&T compliant drawing are included with the part.

# Nikon's advanced image processing algorithm

In combination with Nikon's new image processing technology, the VMA-2520 provides state-of-the-art image processing. The digital video image outputs are transferred to a PC's IEEE1394 port via the controller and processed for sub-pixel level edge detection. This eliminates the need for a frame grabber in the host computer and enables high-speed, highly-accurate observations and measurements. The 3CCD progressive scan color camera also achieves FOV measurement repeatability equivalent to that of a monochrome camera.

## Video edge probes with auto best-fit function

When the operator clicks the point to be measured, the system automatically rotates the probes, sets them at the optimum position, and sets the probe size, all automatically.

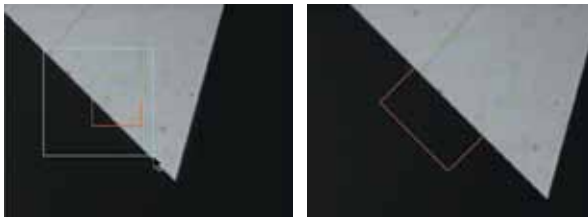

Drag to resize and fit the projection probe to the edge

After this process

## Easy selection of desired edges by eliminating dust and burrs

Some workpieces contain multiple edges within a given caliper, or their contrast is too low, making edge detection extremely difficult. This function graphically profiles the contrasts of the image within the caliper using a multi-gray-level scale, enabling the operator to select any one of a number of edges. Selection of the desired edge is simple: click the appropriate buttons in the edge selection menu and adjust the threshold level using the mouse.

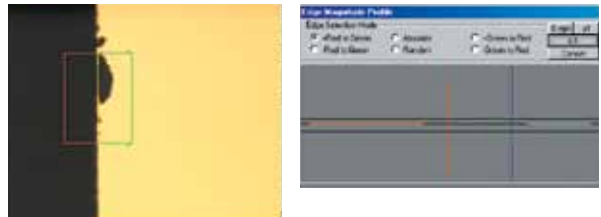

Dust clearly removed by the projection probe

Edge selection graphic window

# Advanced intelligent search

Finding a skewed part location and correcting positional deviations of the edge probing points within a part are programmable by a pattern-matching feature, eliminating possible measurement errors.

## APS (Auto Position Search)

Thanks to this function, the operator no longer needs to manually place multiple workpieces in proper alignment; the iNEXIV automatically searches workpiece location and its orientation.

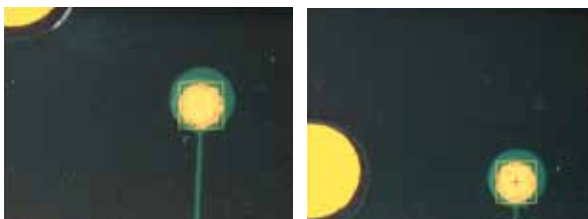

Search on left-side mark

Search on right-side mark



Before APS

After APS

## MPS (Multi-Pattern Search)

Automatically corrects deviations between the edge probing points programmed in a teaching file as well as irregular feature positions without edge probing error.



Normal pin location



Pattern matched on abnormal pin location



Circle probe appears on the abnormal pin location without measurement failure

# User-friendly standard software iNEXIV VMA AutoMeasure

## Main program layout

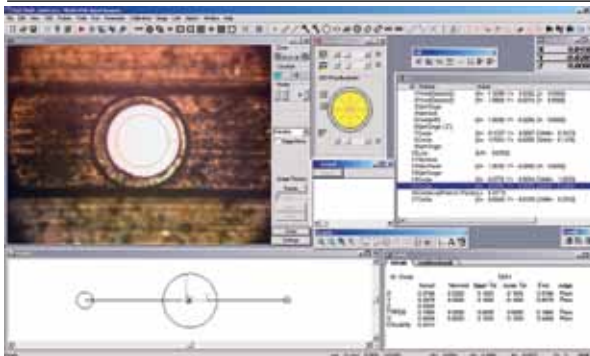

The VMA AutoMeasure software provides enhanced ease of use and versatility because it is based on years of extensive experience with the NEXIV VMR series. An intuitive wizard menu and operation window with large icons can be customized by selecting engineering mode or operator mode. A specified GUI environment can be stored with an individual ID using the ID registration function.

User teach files (parts measurement programs) can now be stored with notes and images for easy recognition and recall. Even the number of mouse clicks required for each operation has been reduced to simplify and speed up the measurement process. Also, iNEXIV VMA AutoMeasure supports a multiple-language environment. The software can switch languages without having to restart the program.

## iNEXIV mode switcher to select proper operation procedures



## Selection of a teaching file with interactive guides



## Interactive measurement wizards

The measurement wizards guide operators, step by step, through what is required to achieve their tasks. In addition to the default wizards, operators can create customized wizards by registering frequently used procedures to streamline future operation.

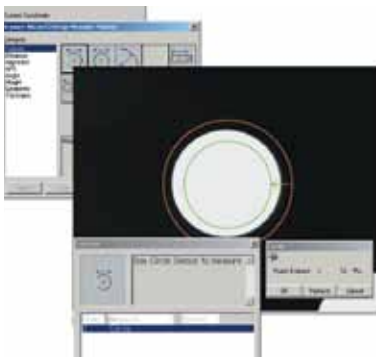

Measurement wizards

## Digital Chart Comparator

VMA AutoMeasure supports Go/No-Go inspection by Charts generated digitally from 2D CAD data. The digital chart is overlaid with the Video Image and can be compared with it real-time. The mode can also be used for recognition of difficult edge lines.



## Online CAD interface program

By importing a workpiece's CAD data in, for example, DXF format, the operator can display graphics in the CAD graphic window on iNEXIV VMA AutoMeasure. This facilitates efficiency in teaching and shortens working time. The operator can move the stage to the desired position by double-clicking the appropriate position within the input workpiece. Also, it is possible to create a teaching file automatically from CAD feature data on iNEXIV VMA AutoMeasure.

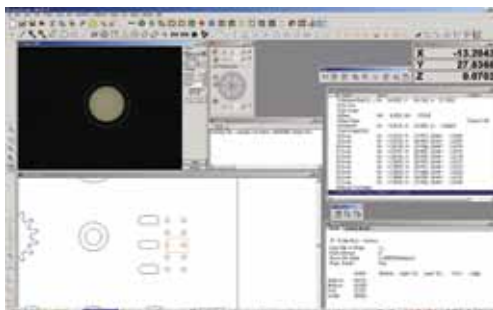



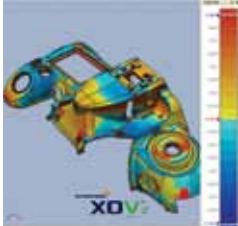

EDF (Extended Depth of Field) and Point Cloud Inspection with 3D CAD by Rapidform XOV/Verifier.

Rapidform XOV<sup>®</sup> is a product of INUS Technology, Inc.



2D CAD Overlay with EDF Image

## Image Analysis & Archiving Program: NEXIV EDF/ Stitching Express

This optional software makes EDF - Extended Depth of Field - images by extracting focused pixel information from multiple captured images in Z-axis direction. Also, it generates stitching images from different FOV images captured with CNC XY stage motion, making a wide FOV observation possible. Both functions contribute to image documentation.

Furthermore, the EDF Images can be stitched into a single EDF Image with wide FOV and can be exported to a point cloud data. The point cloud data can be used for 3D graphical representation and/or 3D color error mapping by comparing with 3D CAD Data.

The 2D CAD overlay combined with the stitched EDF image will produce a form inspection with accuracy and depth exceeding that which can be achieved by eye.

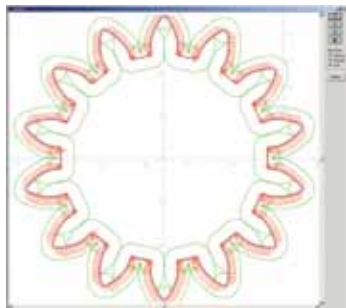

## Two-dimensional profile shape analysis program: iNEXIV VMA Profiler/CAD Reader

iNEXIV VMA Profiler makes it possible to measure and tolerance 2-dimensional profile shapes in a workpiece that cannot be measured in the normal geometric mode. Now more accurate quantitative measurements can be taken than with the chart comparison method using profile projectors and/or conventional measuring microscopes. With the iNEXIV VMA CAD Reader nominal shape data can be created from CAD data in the DXF/IGES file format.

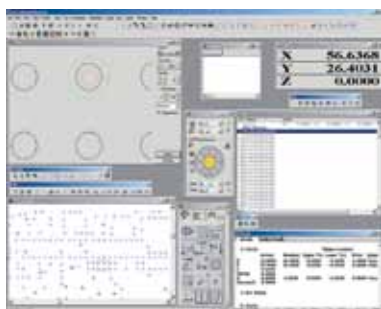

## CAD interface off-line teaching support program: iNEXIV VMA Virtual AutoMeasure

This program enables CAD data to be read into the Virtual Video Window on a separate computer, allowing the operator to use iNEXIV's teaching program with the same operational procedures as on the online computer. This eliminates the necessity of using an actual workpiece during teaching sessions and lets the iNEXIV VMA system concentrate on automatic measurement for increased productivity. The software imports IGES, DXF, DMIS, NC files, Gerber, and so on.

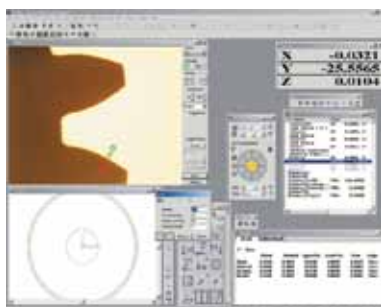

## Gear evaluation software

This software provides evaluations on various parameters of a measured workpiece, including pitch deviations, tooth space runout, base tangent length, and dimension overpin, based on industrial standards.

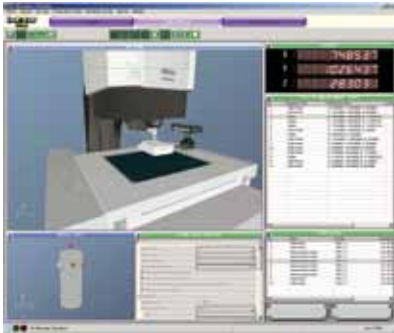

### **Off-line 3D teaching program: 3D Metrology Simulator**

The 3D Metrology Simulator is a simple and affordable program to create feature measurements from 3D CAD Model. The simulator mode will check the probing motion and interference with objects prior to actual measurement.

The optional plug-in, "spGate-Auto" to import different 3D CAD data - IGES, STEP, Parasolid and so on - is also available.

Note: "spGate-Auto" is a product of Armonicos.



### **Report generating program: VMR Report Generator**

This software enables quick generation of inspection result sheets in various report forms including user-designed forms. Users can even customize the program by creating macro scripts to meet any special requirements.

Codevelopment: Pronics Co., Ltd.



### **Report and chart generating program: Custom Fit QC**

Suitable for lot control of inspection data such as maximum value, minimum value, range, standard deviation and process capability index.

In addition to 10 standard inspection result sheet forms, it is possible to customize original forms.

Codevelopment: Aria Co., Ltd.

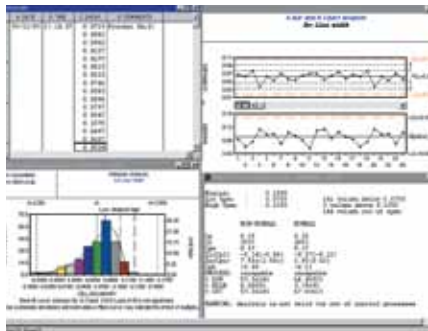

### **Real-time SPC via DDE (Dynamic Data Exchange)**

Using a DDE Link function, measured data can be immediately transferred to spreadsheets such as Microsoft Excel®, SPC-PC IV, SPC-PC IV Excel, and others, making real-time SPC analysis possible.

Note: SPC-PC IV and SPC-PC IV Excel are products of Quality America Inc.



### **Nikon rotary indexer RI-3600L**

The RI-3600L can rotate the image of a workpiece and display it with a 0.01 resolution. Because it can be controlled externally, it enables automatic measurements while controlling the posture of the workpiece.

Minimum readout: 1"

Control resolution: 0.01°

Max. workpiece diameter: 75mm

Operation mode: Auto or Manual

Pre-set points: Point of origin and 3 others

Top view of stage

Unit: mm

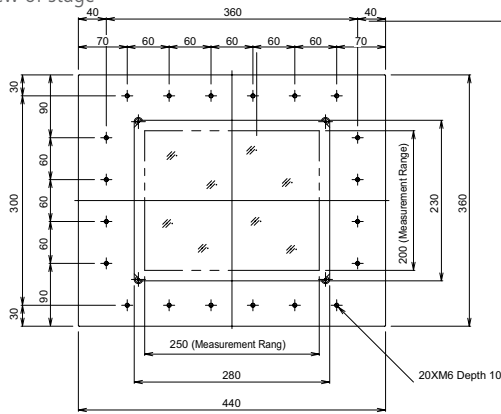

Dimensional diagram

Unit: mm

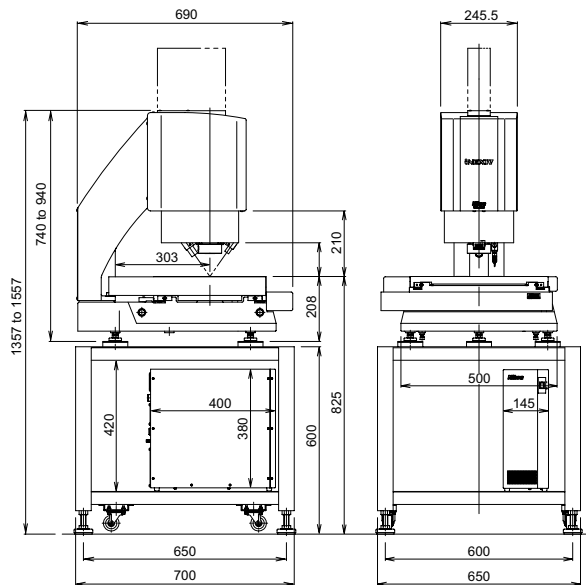

Front view with TP20 & MCR20

Unit: mm

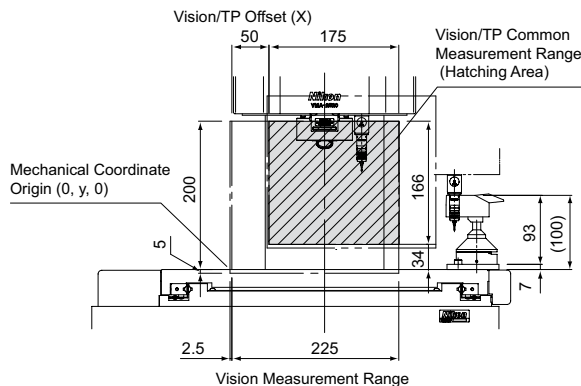

## Specifications

### iNEXIV VMA-2520 main body

Stroke (X x Y x Z) 250 x 200 x 200mm (10" x 8" x 8")

#### Common measurement range

With Touch Probing 200 x 200 x 166mm (TP20)

200 x 200 x 170mm (TP200)

With TP & MCR20 175 x 200 x 166mm (TP20)

175 x 200 x 170mm (TP200)

Minimum readout 0.1μm

Maximum workpiece weight 15kg (up to 5kg accuracy guaranteed)

#### MPE\*

XY MPEE1: 2+8L/1000μmm (with Vision Probing)

XY MPEE2: 3+8L/1000μmm (with Vision Probing)

Z MPEE1: 3+L/50μmm (with Laser AF or Touch Probing)

#### Repeatability (2σ)\*

Vision Probing: 1μm  
Laser AF: 1μm  
Touch Probing: 1μm (probe operates in all three axis directions)

#### Camera

1/3-in. 3CCD color

Progressive scan (B/W optional)

#### Working distance

73.5mm (63mm with LAF)

#### Magnification

Optical: 0.35 to 3.5x

On screen: 12 to 120x (with 17" monitor at SXGA resolution)

See page 5 for details

#### FOV size

13.3 x 10 to 1.33 x 1mm

#### Auto focus

Vision AF and optional Laser AF

#### Illumination

Contour illumination White LED illumination

Surface illumination White LED illumination

Oblique illumination 8-segment white LED ring

#### Video resolution

640 x 480 (pixels)

#### Touch probe

Renishaw® TP200/TP20 (option)

#### Power source

100V-240V, 50/60Hz

#### Power consumption

5A-2.5A

(excluding power consumption of host computer and its peripherals)

#### Dimensions & weight

Main body (W x D x H) 565 x 690 x 740mm (minimum height), 72kg

Controller 145 x 400 x 390mm, 13kg

Table for main body (option) 600 x 700 x 825mm, 38kg

#### Recommended workbench

Min. load capacity 1000kg or more

#### Operational environment

Temperature 10°C to 35°C

Humidity 70% or less

#### Host computer

#### CPU

Intel Core 2 Duo 1.8GHz or faster

#### Graphic Card

For 3D Application programs, please consult Nikon

#### Memory

2G or more

#### Operating system

Windows® XP Pro SP2/Vista Business or later

#### Interface

USB2.0/IEEE 1394

\*Nikon's in-house test at 20°C ±0.5k

Laser AF is a Class 1 Laser Product

**CLASS 1 LASER PRODUCT**

Specifications and equipment are subject to change without any notice or obligation on the part of the manufacturer. February 2009 ©2006-7 NIKON CORPORATION

**WARNING** TO ENSURE CORRECT USAGE, READ THE CORRESPONDING MANUALS CAREFULLY BEFORE USING YOUR EQUIPMENT.

Company names and product names appearing in this brochure are their registered trademarks or trademarks.



**NIKON METROLOGY NV**  
Geldenaaksebaan 329  
B-3001 Leuven, Belgium  
phone: +32 16 74 01 00 fax: +32 16 74 01 03  
[info@nikonmetrology.com](mailto:info@nikonmetrology.com)

**NIKON METROLOGY EUROPE NV**  
tel. +32 16 74 01 01  
[sales\\_europe@nikonmetrology.com](mailto:sales_europe@nikonmetrology.com)  
**NIKON METROLOGY GMBH**  
tel. +49 6023 91733-0  
[sales\\_germany@nikonmetrology.com](mailto:sales_germany@nikonmetrology.com)  
**NIKON METROLOGY SARL**  
tel. +33 1 60 86 09 76  
[sales\\_france@nikonmetrology.com](mailto:sales_france@nikonmetrology.com)

**NIKON METROLOGY, INC.**  
tel. +1 810 2204360  
[sales\\_us@nikonmetrology.com](mailto:sales_us@nikonmetrology.com)  
[www.nikoninstruments.com](http://www.nikoninstruments.com)  
**NIKON METROLOGY UK LTD.**  
tel. +44 1332 811349  
[sales\\_uk@nikonmetrology.com](mailto:sales_uk@nikonmetrology.com)

**NIKON CORPORATION**  
Shin-Yurakucho Bldg., 12-1, Yurakucho 1-chome  
Chiyoda-ku, Tokyo 100-8331 Japan  
phone: +81 3 3773 9026 fax: +81 3 3773 9062  
[www.nikon-instruments.jp/eng/](http://www.nikon-instruments.jp/eng/)

**NIKON INSTRUMENTS (SHANGHAI) CO. LTD.**  
tel. +86 21 5836 0050  
tel. +86 10 5869 2255 (Beijing office)  
tel. +86 20 3882 0550 (Guangzhou office)  
**NIKON SINGAPORE PTE. LTD.**  
tel. +65 6559 3618  
**NIKON MALAYSIA SDN. BHD.**  
tel. +60 3 7809 3609  
**NIKON INSTRUMENTS KOREA CO. LTD.**  
tel. +82 2 2186 8400



More offices and resellers at [www.nikonmetrology.com](http://www.nikonmetrology.com)